



## **TENDER PACKAGE**

Tender No.: PVEP-POC-26-10062

**PROVISION SERVICES OF RETROFIT OF  
DIAGONAL BRACE-TO-COLUMN CONNECTION  
JOINTS OF DAI HUNG 01 FPU**

-----  
CLOSING TIME & DATE

10:00 HOURS, \_\_\_\_ \_\_\_\_\_ 2026 (Vietnam Time)

*PA*

## **GENERAL TABLE OF CONTENTS**

### **INVITATION TO BID (ITB)**

#### **PART I - ITB INSTRUCTIONS**

1. INSTRUCTIONS AND INFORMATION TO BIDDER
2. BIDDER'S QUESTIONNAIRE
3. BIDDING FORMS
4. TECHNICAL EVALUATION CRITERIA

#### **PART II – CONTRACT DOCUMENT**

1. CONTRACT FORM
2. EXHIBITS

EXHIBIT I	SCOPE OF WORKS
EXHIBIT II	EQUIPMENT, MATERIALS, SUPPLIES AND SERVICES TO BE PROVIDED BY CONTRACTOR
EXHIBIT III	CONTRACT PRICE
EXHIBIT IV	FORM OF BANK GUARANTEE
EXHIBIT V	CHANGE ORDER PROCEDURES
EXHIBIT VI	INVOICING AND ADMINISTRATION PROCEDURES/GUIDELINES
EXHIBIT VII	MUTUAL HOLD HARMLESS AGREEMENT
EXHIBIT VIII	HEALTH, SAFETY AND ENVIRONMENT REQUIREMENT

**PART I : ITB INSTRUCTIONS**



## **1. INSTRUCTIONS AND INFORMATION TO BIDDER**

## INSTRUCTIONS AND INFORMATION TO BIDDER

### 1.0 GENERAL

- 1.1 DOMESTIC PETROLEUM OPERATING BRANCH - PETROVIETNAM EXPLORATION PRODUCTION CORPORATION LIMITED (hereinafter referred to as "CLIENT") invites BIDDER to submit proposal for PROVISION SERVICES OF RETROFIT OF DIAGONAL BRACE-TO-COLUMN CONNECTION JOINTS OF DAI HUNG 01 FPU (hereinafter referred to as "WORKS") under Tender No. PVEP-POC-26-10062 as details in this Tender.
- 1.2 In order for CLIENT to fully assess the relative merits of each proposal, BIDDER is requested to furnish CLIENT with all relevant and complete information as set forth in the following items of "INSTRUCTIONS AND INFORMATION TO BIDDER". BIDDER is urged to comply strictly with Tender's requirements.
- 1.3 Eligibility of BIDDER
- a. BIDDER shall be eligible required as follows:
- In case of independent BIDDER:
- **Domestic BIDDER** is to provide notarized copy of eligible certificate of business registration in accordance with Vietnamese Laws;
  - **Foreign BIDDER** is to provide notarized copy of eligible certificate of business registration in accordance with the law of BIDDER's country;
  - BIDDER is an independent cost accounting entity;
  - There is no decision by a competent authority concluding that the BIDDER has an unhealthy financial status; BIDDER is not in bankrupt or insolvent status, and BIDDER is not in the process of dissolution.
- b. In case of Consortium:
- Each Consortium Partner is to provide the documents and to meet the requirements mentioned in paragraph 1.3.a. above.
  - Written Consortium Agreement between the consortium partners specifying responsibilities (joint and several) of each Consortium Partner in implementing the Bid, rights and scope of work and respective value of each Consortium Partner, including the Leading Consortium Partner and its responsibility, place and date of signing the Consortium Agreement, signatures and seals (if any) of Consortium Partners. If the Consortium Partner is authorized as the Leading Partner to sign the Proposal Letter, this effect shall be stated in the Consortium Agreement).
- c. BIDDER participates in bid must be legally and financially independent with Investor and/or Procuring Entity. Failure to comply with such requirement may be considered as disqualified.

- 1.4. BIDDER must submit its proposal strictly in accordance with the terms of the ITB which consists of the following:

**PART I - ITB INSTRUCTIONS**

INSTRUCTIONS AND INFORMATION TO BIDDER

BIDDER'S QUESTIONNAIRE

BIDDING FORMS

TECHNICAL EVALUATION CRITERIA

**PART II – CONTRACT DOCUMENT**

CONTRACT FORM

**EXHIBITS:**

EXHIBIT I	SCOPE OF WORKS
EXHIBIT II	EQUIPMENT, MATERIALS, SUPPLIES AND SERVICES TO BE PROVIDED BY CONTRACTOR
EXHIBIT III	CONTRACT PRICE
EXHIBIT IV	FORM OF BANK GUARANTEE
EXHIBIT V	CHANGE ORDER PROCEDURES
EXHIBIT VI	INVOICING AND ADMINISTRATION PROCEDURES/GUIDELINES
EXHIBIT VII	MUTUAL HOLD HARMLESS AGREEMENT
EXHIBIT VIII	HEALTH, SAFETY AND ENVIRONMENT REQUIREMENT

- 1.5 As a base case, **BIDDER's proposal should be in full conformity with the requirements as set out in the Tender.** Nothing shall be deemed to change or supplement this basis except revisions or addendum to the Tender issued in writing by CLIENT to BIDDER. If BIDDER wishes to present an alternative (**applicable to Technical Specifications ONLY**), BIDDER may do so (as an option to CLIENT) only after having duly complied with the requirements of the Tender.
- 1.6 Any queries concerning preparation of the proposal shall be directed in writing to the address given in item 8.3.
- 1.7 All Bid Proposals must be signed by an officer duly authorized by BIDDER to do so.
- 1.8 Any amendment appearing in the Bid Proposal must be signed or initialed by an officer duly authorized by BIDDER to do so.
- 1.9 BIDDER is to ensure that all prices and other details in the proposal are correct at the time of submission. CLIENT will not entertain any changes or addenda due to typing or calculation errors after the Bid Closing Date.
- 1.10 BIDDER is to bear responsibility for and pay all costs, expenses and other charges incurred in preparation and delivery of the proposal to CLIENT's designated

office as stated in item 8.3, irrespective of whether an order is placed or not.

- 1.11 Submission of proposal by BIDDER will constitute a firm offer by BIDDER that BIDDER is prepared to enter into Contract with CLIENT on the conditions shown in this Tender.
- 1.12 Proposal by BIDDER shall be binding for a minimum period of **120 calendar days from the Bid Closing Date**. BIDDER may assume that the award for Contract will be made within 120 calendar days from the Bid Closing Date and BIDDER can assume that it has not been successful if no notification is received within the bid validity period. BIDDER shall state the precise date of validity in the proposal. CLIENT shall be entitled to request BIDDER to extend Bid Validity for maximum of 60 calendar days (if any) without any BIDDER's exception.
- 1.13 BIDDER is requested to use the term "CONTRACTOR" instead of its specific company business name in their submission of Bid Proposal except for covering letter, header and footer.
- 1.14 At any time prior to Bid Closing Date, CLIENT, for any reason, whether at its own initiative or in response to a clarification requested by BIDDER, may modify the Tender by amendment (including the extension of Bid Closing Date, if necessary) by sending the amendment of Tender in writing to all BIDDERS prior to the Bid Closing Date. These amendments shall be the part of ITB. BIDDERS shall notify to CLIENT by email or by fax to acknowledge their receipt of said amendments.
- 1.15 FAILURE TO STRICTLY COMPLY WITH THE INSTRUCTION AS SET FORTH IN THIS DOCUMENT WILL RESULT IN BIDDER'S PROPOSAL BEING DEEMED NON-RESPONSIVE IN WHICH CASE IT MAY BE DROPPED FROM FURTHER CONSIDERATION.

## **2.0 INTENTION TO BID**

- 2.1 BIDDER is advised to thoroughly check the completeness of the Tender upon receipt. BIDDER must inform CLIENT within three (3) days from the bid issue date if any of the pages are missing.
- 2.2 BIDDER is required to acknowledge receipt of the Tender in accordance with the Tender Acknowledgement Letter Form set out in BIDDING FORMS and intention to submit proposal or otherwise by fax **at least two (2) working days** from bid issuance date. BIDDER is also advised to confirm its address and name a representative to whom all communications from CLIENT shall be addressed to.
- 2.3 Should BIDDER decline to submit a proposal, BIDDER shall state in writing the reason(s) for declining and is required to promptly return the Tender to CLIENT, and in all such cases this shall be done not later than the bid closing date.
- 2.4 All Tender documents returned shall be forwarded to the address as given in item 9.3 herein, with the following wordings clearly marked on the cover/envelope.
  - (a) "DECLINE TO BID-DOCUMENTS RETURNED"
  - (b) TENDER NUMBER and TITLE

(c) BIDDER'S NAME

### **3.0 EXCLUSIVITY OF BID**

BIDDER is required to submit Bid Proposal in conjunction with the Principal and the Principal MUST be the prime vendor for the total proposal package. BIDDER is also required to submit a support letter from Principal (if any).

### **4.0 PRICE QUOTATION**

- 4.1 The price quotation shall be quoted in Vietnamese Dong (VND), for Domestic BIDDER or United States Dollar (USD), for Foreign BIDDER.
- 4.2 **Once specified, the unit prices shall prevail throughout the life of the Contract and shall not be subject to revision by reason of cost escalation nor currency fluctuations.**
- 4.3 PRICE OF COMPENSATION
  - 4.3.1 BIDDER's Bid Proposal shall be in full conformity with the requirements as set out in this Bid documents.
  - 4.3.2 BIDDER should specifically note that subsequence to the Bid Closing Date, no alteration in price quotation will be permitted whatsoever.
  - 4.3.3 Prices are to be itemized according to the item numbers in the Commercial Proposal Form attached hereto. Unit price and total price must be clearly stated in the quotation. All discounts, in percentage of total estimated contract value, are to be stated separately.
- 4.4 The proposed CONTRACT PRICE shall indicate whether it is inclusive of Vietnamese taxes (VAT, CIT, etc.) or not. In the event that the quoted prices do not specify this, they shall be treated as inclusive of all taxes.

### **5.0 BID EXCEPTIONS**

In the event BIDDER has any change that is considered of mutual benefit or if there is any exception to Tender document, BIDDER must state the changes or exceptions proposed by using the Exception Form as set out in BIDDING FORMS and giving specific reasons thereof.

Changes or exceptions to the Tender document expressed after the Bid Closing Date will not be entertained.

CLIENT reserves the right to accept or reject any or all of the proposed changes or exceptions. CLIENT will review each change or exception on a case by case basis.

### **6.0 BANK GUARANTEE**

#### **6.1 BID BOND**

- 6.1.1 When participating to the Bid, BIDDER shall, at its own expense, furnish

Bid Bond using the Bid Bond Form set out in BIDDING FORMS and issued by an reputable recognized bank accepted by CLIENT.

- 6.1.2 The amount of Bid Bond shall be 80,000,000 VND (*In words: eighty million Dong*) and shall be valid for **150 days from the Bid Closing Date**. The Original Bid Bond shall be attached in the Bid Proposal.
- 6.1.3 In case of Consortium, the Bid Bond will be provided by one of the following two methods:
- a) Each Consortium Partner shall provide separately Bid Bond, provided always that the total value of Bid Bond shall not be lower than the amount required in Item 6.1.2 above; if Bid Bond of any Consortium Partner is invalid the Bid Proposal of such Consortium shall be rejected according to the prerequisite criteria.
  - b) The Consortium Partners agree to appoint a Consortium Partner to provide Bid Bond for the whole Consortium. In this case, the Bid Bond may include the name of Consortium or name of the Consortium Partner providing the Bid Bond for the whole Consortium provided always that the total value of Bid Bond shall not lower than the amount required in Item 6.1.2 above.
- 6.1.4 Bid Bond shall be considered as not acceptable if its value is lower than the required value, is not in the required currency, with shorter validity period, not submitted to the address by the time required by the ITB, states an incorrect BIDDER'S Name, is not original or without valid signature.
- 6.1.5 Bid Bond will be returned to the unsuccessful BIDDER within thirty (30) days from the date of announcement of the Bid results. For the successful BIDDER, the Bid Bond will be returned when the successful BIDDER provides the Bank Guarantee.
- 6.1.6 Bid Bond shall be forfeited and shall be disposed if the BIDDER:
- a) withdraws its Bid Proposal during the Validity Period of the Bid or any extension of validity the BIDDER has agreed to;
  - b) do not commence the contract negotiation, finalization or decline to do so within thirty (30) days after receipt of contract award notice, or have completed the contract negotiation, finalization but refuses to sign the contract without valid reasons;
  - c) in case of the successful BIDDER, fails to furnish the performance bond before signing the contract or before the contract comes into force.

## 6.1 BANK GUARANTEE

BIDDER's attention is drawn to **Article headed as BANK GUARANTEE** of the CONTRACT FORM whereby the successful BIDDER is requested to provide an irrevocable first call Bank Guarantee issued by a commercial bank acceptable by CLIENT to guarantee performance of BIDDER's obligation under the CONTRACT. The format of Bank Guarantee shall be set out in the EXHIBIT V of

CONTRACT document.

## **7.0 PROPOSAL FORMAT**

7.1 BIDDER is to strictly adhere to the proposal format as set out below. **BIDDER must ensure that the "TECHICAL AND UNPRICED PACKAGE (TECHNICAL)" does not contain any pricing or cost.** Failure to comply with these instructions may render BIDDER's proposal invalid.

7.2 BIDDER is to submit the proposal in two (2) separate packages, as follows:

a) Technical and Unpriced Package (Technical)

b) Priced Package (Commercial)

7.3 **CONTENTS OF TECHNICAL AND UNPRICED PACKAGE (TECHNICAL)**

Unpriced package shall include but not limited to the following:

<b>SECTION</b>	<b>CONTENT</b>
Section 1	<b>PROPOSAL LETTER</b> The Proposal Letter shall be prepared and fully filled by BIDDER as set out in BIDDING FORMS and must be signed by the authorized representative of BIDDER (the representative at law of the BIDDER or the authorized person with legal Power of Attorney). In case of authorization, BIDDER shall enclose the following instruments and documents to prove the legitimacy of the authorized person: a. In case of independent BIDDER: Power of Attorney signed by the Representative at law of BIDDER authorizing the authorized person to sign the Proposal Letter; b. In case of Consortium: Proposal Letter shall be signed by the Representative at law of each Consortium Partner, unless the Consortium Agreement stated that the Consortium Partners have authorized the representative at law of Leading Partner of the Consortium to sign Proposal Letter. If each Consortium Partner has authorized such Representative, the same requirements as independent Bidder shall be applied.
Section 2	<b>BIDDER'S ELIGIBILITY, EXPERIENCES AND CAPACITY</b> BIDDER shall provide the following documents proving BIDDER's eligibility, experiences, and capacity: 1. The Documents as required in Item 1.3; 2. BIDDER is requested to submit a completed BIDDER's QUESTIONNAIRE, including but not limitation to the following documents: (i) BIDDER's Organization (ii) BIDDER's Experience; (ii) Company Profile; and (iii) Last 3 Year Financial Statement.
Section 3	<b>TECHNICAL PROPOSAL</b> BIDDER shall provide the following documents to prove the

	<p>suitability (compliance) of WORKS:</p> <ol style="list-style-type: none"> <li>1. BIDDER is to provide (i) the detailed description of the working procedures, BIDDER's capability of the WORKS proposed and (ii) the relevant guidelines, drawings, certificates, records to provide the Scope of WORKS as specified in EXHIBIT I - SCOPE OF WORKS;</li> <li>2. BIDDER is to fill the information as per EXHIBIT II – EQUIPMENT, MATERIALS, SUPPLIES AND SERVICES TO BE PROVIDED BY CONTRACTOR;</li> <li>3. Curriculum Vitae (CV) of Proposed Manpower as set out in BIDDING FORMS;</li> </ol>
Section 4	<p><b>BIDDER'S UNPRICED EXCEPTIONS AND ALTERNATIVES</b></p> <ol style="list-style-type: none"> <li>a. If BIDDER has no exception and alternative proposal, BIDDER shall have the following statements prominently displayed in capital letters under this section: "THIS PROPOSAL COMPLIES WITH ALL TERMS AND CONDITIONS OF THIS CONTRACT, EXHIBITS AND REQUIREMENTS IN THIS ITB" or</li> <li>b. If BIDDER has alternative proposal on this bid documents, BIDDER shall display the following statement in capital letters under this section: "THIS PROPOSAL INCLUDES EXCEPTIONS AND ALTERNATIVES WHICH ARE LISTED ON THE FOLLOWING PAGES." BIDDER shall present a complete and detailed listing of non-compliance to the ITB in total indicating the delivery impact only, if any, but without indicating the cost impact. The format of presentation shall be as per the attached BIDDER's EXCEPTION TO TERMS AND CONDITIONS and BIDDER's EXCEPTION TO EXHIBITS as set out in BIDDING FORMS.</li> </ol>
Section 5	<p><b>BID BOND</b> BIDDER shall provide the Original Bid Bond as requested in Item 6.1.</p>

7.4 CONTENTS OF PRICED PACKAGE (COMMERCIAL)

Every page of BIDDER's price proposal must bear BIDDER's company seal. Priced package shall include the following:

SECTION	CONTENT
Section 1	<p><b>PROPOSAL LETTER</b> To be attached a similar letter as in Section 1.</p>
Section 2	<p>BIDDER is requested to submit the following with prices &amp; schedule attached <b>PRICE COMMERCIAL FORM</b> as per EXHIBIT III – CONTRACT PRICE</p>
Section 3	<p><b>BIDDER's PRICED EXCEPTIONS AND ALTERNATIVES.</b></p> <ol style="list-style-type: none"> <li>a. If BIDDER has no exception and alternative proposal, BIDDER shall have the following statements prominently displayed in capital letters under this section: "THIS PROPOSAL COMPLIES WITH ALL TERMS AND CONDITIONS OF THIS CONTRACT, EXHIBITS AND</li> </ol>

	<p>REQUIREMENTS IN THIS TENDER" or</p> <p>b. If BIDDER has alternative proposal on this bid documents, BIDDER shall display the following statement in capital letters under this section: "THIS PROPOSAL INCLUDES EXCEPTIONS AND ALTERNATIVES WHICH ARE LISTED ON THE FOLLOWING PAGES."</p> <p>BIDDER shall present a complete and detailed listing of non-compliance to the Tender in total indicating the delivery impact and cost impact, if any. The format of presentation shall be as per the attached BIDDER's EXCEPTION TO TERMS AND CONDITIONS and BIDDER's EXCEPTION TO EXHIBITS as set out in BIDDING FORMS.</p>
--	--

## **8.0 SUBMISSION OF PROPOSAL**

8.1 Each Technical and Unpriced Package (Technical) and Priced Package (Commercial) shall consist of:

- a) **One (1) original set** of each package wrapped separately from the other copies and clearly marked with the word "**ORIGINAL UNPRICED**" or "**ORIGINAL PRICED**" on the cover of the respective wrapping.
- b) **One (1) copy** each of the Technical and Unpriced Package (Technical) and Priced Package (Commercial). The copies shall be wrapped separately (01 Unpriced and 01 Priced) and marked with the word "**COPIES UNPRICED PACKAGE**" or "**COPIES PRICED PACKAGE**" on the covers of the packages.

In the event of discrepancy between the original set and the copies, the original set shall prevail.

8.2 BIDDER shall ensure that all proposals or submissions to CLIENT, pertaining to the enquiry are properly sealed and that the cover of each package is clearly marked in **bold letters** with the following wordings:

- (a) Tender number and the title.
- (b) BIDDER's name and return address.
- (c) "TECHNICAL AND UNPRICED PACKAGE" or "PRICED PACKAGE".
- (d) "PRIVATE AND CONFIDENTIAL"

8.3 **All communications and correspondence with regard to Tender and clarification shall be made to the following address:**

**DOMESTIC PETROLEUM OPERATING BRANCH - PETROVIETNAM  
EXPLORATION PRODUCTION CORPORATION LIMITED**

15<sup>th</sup> Floor, Victory Tower

12 Tan Trao Street, Tan My Ward

Ho Chi Minh City, S.R Vietnam

Tel: (84-28) 3776 2222

Fax : (84-28) 3872 1088

Attention : **Planning & Procurement Manager**

All communications with regard to bid clarifications shall be made in writing and

must indicate the Tender number and title and send to the address given above. Such bid clarifications shall reach the address given above at least ten (10) days prior to the Bid Closing Date. CLIENT shall preserve the right not to response to bid clarifications received later than the above-mentioned time.

**Submission of Bid Proposal shall be made to the following address:**

*\*For any further information, please contact email: [anhnd-tmdt@pvpep.com.vn](mailto:anhnd-tmdt@pvpep.com.vn)*

**DOMESTIC PETROLEUM OPERATING BRANCH - PETROVIETNAM  
EXPLORATION PRODUCTION CORPORATION LIMITED**

15<sup>th</sup> Floor, Victory Tower

12 Tan Trao Street, Tan My Ward

Ho Chi Minh City, S.R Vietnam

Tel: (84-28) 3776 2222

Fax : (84-28) 3872 1088

Attention : **Planning & Procurement Manager**

- 8.4 BIDDER is strongly advised to deliver the proposals by hand in order to assure timely receipt by CLIENT. If BIDDER elects to mail the proposal, BIDDER is advised to use a fast and reliable delivery service e.g. courier. BIDDER should advise CLIENT by fax the date on which the proposal was mailed and details of the delivery service.
- 8.5 Responsibility for timely delivery of the proposals to the correct address rests fully with BIDDER. CLIENT does not accept late bids submission. Delivery to the wrong address shall not be an excuse for late delivery.
- 8.6 BIDDER must ensure that the proposal is delivered to the address given in Item 8.3 above no later than **10:00 hours on \_\_\_\_\_ 2026. LATE BIDS WILL NOT BE ENTERTAINED.**
- 8.7 BIDDER's proposal shall be submitted in a **separate sealed envelope or package** bearing the name of your company, clearly addressed and marked on the outside as follows:

**"STRICTLY CONFIDENTIAL"**

**PROVISION SERVICES OF RETROFIT OF DIAGONAL BRACE-TO-COLUMN  
CONNECTION JOINTS OF DAI HUNG 01 FPU**

**ITB: PVPEP-POC-26-10062**

- 8.8 Bid Proposal as well as all correspondences and documents relating to the Tender exchanged by BIDDER and CLIENT shall be written in English. Supporting documents and printed literature furnished by BIDDER may be in another language provided they are accompanied by an accurate translation of the relevant passages in English, in which case, for purposes of interpretation of the Bid Proposal, the translation shall govern.

**9.0 ACCEPTANCE**

- 9.1 CLIENT may, at CLIENT option, reject all proposals received or may accept any proposal which, in CLIENT's sole judgment, is the most advantageous to CLIENT. CLIENT reserves the right to accept or reject all or part of the proposal at CLIENT's discretion and will be under no obligation to explain the reasons thereof.
- 9.2 CLIENT reserves the right to award the CONTRACT at its own discretion. Award

Strategy: **Single Award.**

- 9.3 CLIENT shall not be deemed to have accepted all or any part of a proposal unless and until a written acceptance is issued.
- 9.4 Any award as a result of this ITB will be through a properly executed contract issued by CLIENT. Prior to this, CLIENT may send the BIDDER a Letter of Award in order to initiate immediate placement of order. Upon receipt of the Letter of Award, BIDDER shall proceed immediately with the work mentioned in the Letter of Award.

**10.0 PAYMENT**

- 10.1 Payments shall be made in accordance to **Article headed as INVOICING AND PAYMENT** of Contract Form attached hereto.
- 10.2 Any proposal on progress payments shall be based on "value received" or verifiable milestones and not merely the passage of time and not for merely placing the Contract.

**END OF SECTION**

## 2. BIDDER'S QUESTIONNAIRE



(This form **MUST** be completely filled by BIDDER. Write 'NIL' or 'NOT APPLICABLE' where appropriate)  
**PRIVATE & CONFIDENTIAL**

1. Full Name of BIDDER: \_\_\_\_\_  
Registered Address: \_\_\_\_\_  
Business Address: \_\_\_\_\_  
Correspondence Address: \_\_\_\_\_  
Telephone: \_\_\_\_\_  
Fax: \_\_\_\_\_

2. BIDDER's Organization:  
BIDDER is requested to provide a brief description of the background and organization of BIDDER.

3. List of similar Projects and Contract performed in the last three years:

Name of Project:.....	Approx. Value of Contract (in current US\$/VND):.....
Country:.....	Duration of Project (months):.....
Location within country:.....	
Name of Client:.....	Total N <sup>o</sup> of staff-months provided to the Project:.....
Address:.....	Start Date (month/year):.....
	Completion Date (month/year):.....
Narrative description of Project:.....	Description of actual services provided by BIDDER's staff within Project:.....
Name of senior professional staff of BIDDER involved and functions performed (indicate most significant profiles such as Project Director/Coordinator, Team Leader):.....	
.....	
.....	

Note: BIDDER shall attach a copy of documents, materials related to above contracts (certified by the Project Owner for the contract being implemented according to the related information in above table).

4. Summary of Financial Data for the fiscal years

Unit: (VND/ USD)

No.	Descriptions	2022	2023	2024
1	Total assets			
2	Total liabilities			
3	Current assets			
4	Current liabilities			
5	Turnover			
6	Profit Before Tax			
7	Profit after Tax			
8	Other items (if required)			

For the purpose of verification of the data declared, BIDDER is required to submit the notarized/certified true copy of the following documents:

1. Audited Financial Statements or Financial Statements certified by competent authorities as required by the law for the Year 2022, 2023, 2024.
2. Annual Tax Statements as required by the law on taxation (Tax authorities to certify that the Bidder has submitted its tax statements) for the Year 2022, 2023, 2024;
3. Report on Checking of Bidder's Tax Statements (if any) for the Year 2022, 2023, 2024.

Information provided by:

Name: \_\_\_\_\_  
Designation: \_\_\_\_\_  
Company: \_\_\_\_\_

Signature: \_\_\_\_\_  
Date: \_\_\_\_\_

*A*

### 3. BIDDING FORMS

**TENDER ACKNOWLEDGMENT LETTER**

*Letterhead of Bidder*

Date:  
To: **DOMESTIC PETROLEUM OPERATING BRANCH - PETROVIETNAM  
EXPLORATION PRODUCTION CORPORATION LIMITED**  
Attn: Director  
Subject: TENDER FOR .....  
TENDER No. PVEPPOC-26-.....

Dear Sir,

- We acknowledge receipt of the subject Invitation to Bid ("ITB").
- We have received all documents without damage and in usable condition.
- We have read the Instructions to Bidders and will submit a bid in accordance with the Tender requirements.
- We confirm our adherence to the highest standards of business ethics and, in particular, we have established precautions to prevent any of our officers, employees, or agents from making, receiving, providing or offering substantial gifts, entertainment, payment, loans or other considerations which may influence individuals.

**OR**

- We do not wish to bid and therefore we are returning this Tender in its entirety with this Tender Acknowledgement Letter.

All future communications in respect of this ITB should be addressed as follows:

Bidder's  
Name: \_\_\_\_\_ Telephone: \_\_\_\_\_  
Attention: \_\_\_\_\_ Fax: \_\_\_\_\_  
Address: \_\_\_\_\_ Email: \_\_\_\_\_  
Signed: \_\_\_\_\_

Signature: \_\_\_\_\_ Date: \_\_\_\_\_  
Printed  
Name: \_\_\_\_\_  
Title: \_\_\_\_\_

**PROPOSAL LETTER FORM**

*Letterhead of BIDDER*

Date:

To           **DOMESTIC PETROLEUM OPERATING BRANCH -  
PETROVIETNAM EXPLORATION PRODUCTION CORPORATION  
LIMITED**

Attn:        Director

**Subject:     TENDER FOR.....**  
              TENDER No. PVEP POC-.....

Dear Sir

We, the undersigned, certify that we have read and understood the subject Invitation to Bid and all documents forming the Bid Document.

We acknowledge that we have thoroughly investigated, or have had the opportunity to do so, and satisfied ourselves as to all conditions affecting the WORKS and all necessary information as to risk contingencies and all circumstances influencing and affecting this Bid Document.

We offer to provide the WORKS as detailed in the Bid Package for the prices stated in our Proposal attached hereto. This offer is valid until 120 days from the date fixed for submitting same and shall be binding upon us and may be accepted at any time before the aforesaid date.

If our proposal is accepted, we undertake that, unless and until a formal CONTRACT is prepared and executed, this Bid Proposal, together with your written acceptance shall constitute            a            binding            contract            between            us.

Yours faithfully

Correspondence from CLIENT should be addressed to:

Signature :  
Printed Name :  
Position :  
Company:  
Date :

Address :  
Attn :  
Telephone :  
Telex :  
Fax:

**POWER OF ATTORNEY FORM**

*Letterhead of BIDDER*

Date:

To           **DOMESTIC PETROLEUM OPERATING BRANCH -  
PETROVIETNAM EXPLORATION PRODUCTION CORPORATION  
LIMITED**

Attn:       DIRECTOR

**Subject:    TENDER FOR .....**  
              TENDER No. PVEPPOC-.....

I, the undersigned - the Legal Representative of .... [Name of BIDDER], hereby authorize and empower [name of Authorized Person and Position] to be my true and lawful attorney to

1.     Signing Proposal Letter;
2.     Signing transaction documents, correspondence with CLIENT during the Bidding Process, including, but not limit to, ITB Clarification Request, Bid Clarification;
3.     Participating in Contract Negotiation and Finalization;
4.     Signing petitions if the BIDDER has any petitions;
5.     Signing contract with CLIENT if we are selected

for ..... under the TENDER No. PVEP POC-.....

This Power of Attorney is effective as from \_\_\_\_\_ to \_\_\_\_\_.

Yours faithfully,

**For and behalf of [name of BIDDER].**

\_\_\_\_\_

**Name of Legal Representative of BIDDER**

**Position:**

## CONSORTIUM AGREEMENT FORM

\_\_\_\_\_, Date: \_\_\_\_\_

TENDER: .....

TENDER No. PVEPPOC-.....

We, representatives of the Parties of the Consortium Agreement, including:

Name of the Consortium Partner (Name of Each Consortium Partners) \_\_\_\_\_

Represented by: \_\_\_\_\_

Title: \_\_\_\_\_

Address: \_\_\_\_\_

Power of Attorney No. \_\_\_\_\_ dated \_\_\_\_\_ (in case of authorization).

The Parties (hereinafter referred to as Partners) agreed to enter into this Consortium Agreement with the following terms and conditions:

### **Article 1: General Provisions**

1. The Partners are willing to form a Consortium to participate in the Tender No. PVEP POC-..... for ..... (hereinafter referred to as "TENDER") to DOMESTIC PETROLEUM OPERATING BRANCH - PETROVIETNAM EXPLORATION PRODUCTION CORPORATION LIMITED (hereinafter referred to as "CLIENT").
2. The Partners agree that the name of the Consortium for all correspondences related to TENDER is: \_\_\_\_\_ [specify name of the Consortium as agreed].
3. The Partners confirm that neither of them will unilaterally participate in the bidding of this ITB as an independent Bidder of partner of other consortium. If the consortium is awarded the Contract, neither partner will refuse to execute its obligations and duties as agreed in the Contract unless otherwise agreed in writing by the Consortium Partner. If the Consortium Partner refuses to fulfill its own obligations as agreed then such Partner is to:
  - Compensate for all damages to other Consortium Partners;
  - Compensate for all damages to CLIENT as stipulated in the Contract;
  - Other penalty [specify other penalty].

### **Article 2. Responsibilities of the Partners**

The Partners agree that the responsibilities of each Partner for execution of the Tender shall be as follows:

1. Leading Partner of the Consortium:

The Partners agreed to appoint \_\_\_\_\_ *[specify the name of Leading Partner of the Consortium]* to be the Leading Partner of the Consortium to act on behalf of the Consortium in the following works:

- 1.1. Signing Proposal Letter;
  - 1.2. Signing transaction documents, correspondence with CLIENT during the Bidding Process, including, but not limit to, Tender Clarification Request, Bid Clarification;
  - 1.3. Participating in Contract Negotiation and Finalization;
  - 1.4. Signing petitions if the Bidder has any petitions;
  - 1.5. Signing Contract with CLIENT if we are selected
2. The Consortium Partners:

*[Specify the scope of work, responsibilities of each Partner, including the Leading Partner of the Consortium and, if possible, to specify the percentage of appropriate value].*

**Article 3: Validity of the Consortium Agreement**

1. This Consortium Agreement is valid from the date of signing.
2. This Consortium Agreement will expire in any of the following cases:
  - The Partners completed their obligations, duties and agreed to liquidate the Contract;
  - The Partners agreed to terminate this Agreement;
  - Cancellation of Bidding Process of the Tender according to the notification of CLIENT.

This Consortium Agreement is made in \_\_\_\_ originals, each Partner will keep \_\_\_\_ original(s), all originals are equally valid.

**LEGAL REPRESENTATIVE OF THE LEADING CONSORTIUM PARTNER**

*[Specify full name, title, sign and seal]*

**LEGAL REPRESENTATIVES OF THE CONSORTIUM PARTNERS**

*[Specify full name, title, sign and seal of each Consortium Partner]*

**BID BOND FORM**

*Letterhead OF BANK*

BID BOND TO ITB No. PVEP POC-.....

Date: \_\_\_\_\_

To: **DOMESTIC PETROLEUM OPERATING BRANCH - PETROVIETNAM EXPLORATION PRODUCTION CORPORATION LIMITED** (hereinafter referred to as the "CLIENT")

Basing on the fact that \_\_\_\_\_ [*name and registered head office address of the BIDDER*], (hereinafter referred to as "BIDDER"), will participate to the Bidding for your ITB No. for the .....

We \_\_\_\_\_ [*name of the BANK*], having registered office located at \_\_\_\_\_ [*address of registered office of the BANK*] (hereinafter referred to as "BANK"), pledge to BIDDER to secure for the Bidder to participate in bidding for said ITB with an amount of ..... VND (*in words: seventy-two million Dong*)

We shall immediately transfer to CLIENT the amount of money mentioned above when CLIENT notifies in writing that Bidder breaks the requirements specified in the ITB documents<sup>(1)</sup>.

This Bid Bond is valid for **150 days** from the bid closing date. Any claim of CLIENTY related to this Bid Bond shall be received by [*name of the BANK*] before expiry of above mentioned validity period.

**Legal Representative of the BANK**

[*Specify name, title, sign and seal*]

Notes:

<sup>(1)</sup> *If the Bidder is a Consortium and the Consortium Partners provide separate Bid Bond or one Consortium Partner provides Bid Bond for the entire Consortium, then this requirement will be amended as follows: "We shall immediately transfer to CLIENT the amount of money mentioned above when CLIENT notifies in writing that BIDDER or any Partner in BIDDER's Consortium breaks the requirements specified in the ITB documents".*

## CURRICULUM VITAE (CV) FOR PROPOSED MANPOWER

1. **Proposed Position** [*only one candidate shall be nominated for each position, one candidate may be nominated for some tasks assigned*]: \_\_\_\_\_

2. **Name of Firm** [*Insert name of firm proposing the staff*]: \_\_\_\_\_

3. **Name of Staff** [*Insert full name*]: \_\_\_\_\_

4. **Date of Birth:** \_\_\_\_\_ **Nationality:** \_\_\_\_\_

5. **Education** [*Indicate college/university and other specialized education of staff member, giving names of institutions, degrees obtained, and dates of obtainment*]: \_\_\_\_\_

6. **Membership of Professional Associations:** \_\_\_\_\_

7. **Other Training** [*Indicate significant training since degrees under 5 - Education were obtained*]: \_\_\_\_\_

8. **Countries of Work Experience:** [*List countries where staff has worked in the last ten years*]: \_\_\_\_\_

9. **Languages** [*For each language indicate proficiency: good, fair, or poor in speaking, reading, and writing*]: \_\_\_\_\_

10. **Employment Record** [*Starting with present position, list in reverse order every employment held by staff member since graduation, giving for each employment (see format here below): dates of employment, name of employing organization, positions held.*]:

From [Year]: \_\_\_\_ To [Year]: \_\_\_\_\_

Employer: \_\_\_\_\_

Positions held: \_\_\_\_\_

<p><b>11. Detailed Tasks Assigned</b></p> <p style="text-align: center;"><i>[List all tasks to be performed under this assignment]</i></p>	<p><b>12. Work Undertaken that Best Illustrates Capability to Handle the Tasks Assigned</b></p> <p><i>[Among the assignments in which the staff has been involved, indicate the following information for those assignments that best illustrate staff capability to handle the tasks listed under point 11. <b>IT IS IMPORTANT</b> that the staff should list <u>ALL</u> such relevant assignments.]</i></p> <p>Name of assignment or project: _____</p> <p>Year: _____</p> <p>Location: _____</p> <p>Client: _____</p> <p>Main project features: _____</p> <p>Positions held: _____</p>
--	---

A

	Activities performed: _____
--	-----------------------------

**13. Certification:**

I, the undersigned, certify that to the best of my knowledge and belief, this CV correctly describes myself, my qualifications, and my experience. I understand that any wilful misstatement described herein may lead to my disqualification or dismissal, if engaged.

\_\_\_\_\_ Date: \_\_\_\_\_

*[Signature of staff member or authorized representative of the staff]*

*Day/Month/Year*

Full name of authorized representative: \_\_\_\_\_

**BIDDER'S EXCEPTIONS TO TERMS AND CONDITIONS**

<b>ARTICLE NO.</b>	<b>EXACT NEW WORDING PROPOSED BY BIDDER</b>	<b>REASON (S) FOR EXCEPTION</b>	<b>ADDITION (+) OR REDUCTION (-) IN BID PRICE IF EXCEPTION IS ACCEPTED BY CLIENT</b>	<b>EFFECT ON DELIVERY DATE</b>

*[Handwritten signature]* A

**BIDDER'S EXCEPTIONS TO EXHIBITS**

<b>EXHIBIT NO.</b>	<b>EXACT NEW WORDING PROPOSED BY BIDDER</b>	<b>REASON (S) FOR EXCEPTION</b>	<b>ADDITION (+) OR REDUCTION (-) IN BID PRICE IF EXCEPTION IS ACCEPTED BY CLIENT</b>	<b>EFFECT ON DELIVERY DATE</b>

## UNPRICED PROPOSAL FORM

### SCOPE OF WORKS/ SUPPLY

No	Descriptions	UOM	QUANTITY	BIDDER PROPOSAL
1				Bidder to note "Quoted" or "No Quote"
2				
3				
4				
5				

**Note:**

- *The proposed CONTRACT PRICE shall indicate whether it is inclusive of Vietnamese taxes (VAT, CIT, etc.) or not. In the event that the quoted prices do not specify this, they shall be treated as inclusive of all taxes.*
- *Failure to submit this form in accordance with the ITB's requirements may result in the Bidder's proposal being disqualified.*

A

**EVALUATION CRITERIA**  
(AS ATTACHED IN SOW)



**CONTRACT**

**Between**

**DOMESTIC PETROLEUM OPERATING BRANCH - PETROVIETNAM  
EXPLORATION PRODUCTION CORPORATION LIMITED**

**And**

.....

**For**

**PROVISION SERVICES OF RETROFIT OF DIAGONAL BRACE-TO-  
COLUMN CONNECTION JOINTS OF DAI HUNG 01 FPU**

**CONTRACT No.: PVEP-POC-26-10062**

— 2 A



**TABLE OF CONTENT**

<b><u>TITLE</u></b>	<b><u>PAGE</u></b>
PREAMBLE .....	3
ARTICLE 1 - INTERPRETATION OF CONTRACT .....	4
ARTICLE 2 - DEFINITIONS.....	5
ARTICLE 3 - DURATION OF CONTRACT .....	7
ARTICLE 4 - CONTRACT PRICE.....	7
ARTICLE 5 - INVOICING AND PAYMENTS.....	7
ARTICLE 6 - BANK GUARANTEE.....	8
ARTICLE 7 - TAXES AND DUTIES .....	9
ARTICLE 8 - INSURANCE.....	13
ARTICLE 9 - LIABILITIES AND INDEMNITIES.....	15
ARTICLE 10 – ACCEPTANCE OF WORKS .....	16
ARTICLE 11 - WARRANTY.....	16
ARTICLE 12 - CONTRACTOR'S OBLIGATION .....	17
ARTICLE 13 - CLIENT'S OBLIGATION.....	21
ARTICLE 14 - ACTIONS ON BEHALF OF CLIENT.....	21
ARTICLE 15 - CLIENT'S CONTRACT ADMINISTRATOR AND REPRESENTATIVE(S).....	22
ARTICLE 16 – CONTRACTOR'S CONTRACT ADMINISTRATOR AND REPRESENTATIVE .....	22
ARTICLE 17 - LIENS AND CLAIMS.....	23
ARTICLE 18 - SAFETY, HEALTH, ENVIRONMENT.....	24
ARTICLE 19 - DEFAULT OF CONTRACTOR .....	26
ARTICLE 20 - PROVISION FOR SUSPENSION OF WORKS .....	26
ARTICLE 21 - PROVISION FOR TERMINATION OF CONTRACT.....	27
ARTICLE 22 – SUB-CONTRACTS AND ASSIGNMENT .....	28
ARTICLE 23 - ACCESS AND AUDIT RIGHTS .....	29
ARTICLE 24 - CHANGES.....	29
ARTICLE 25 - LIQUIDATED DAMAGES.....	30
ARTICLE 26 - FORCE MAJEURE .....	30
ARTICLE 27 - CONFLICT OF INTEREST .....	31
ARTICLE 28 - WAIVERS .....	32
ARTICLE 29 - CONFIDENTIALITY.....	32
ARTICLE 30 - ARBITRATION.....	34
ARTICLE 31 - COMPLIANCE WITH LAW .....	34
ARTICLE 32 - GOVERNING LAW AND LANGUAGE .....	35
ARTICLE 33 - PATENTS AND OTHER PROPRIETARY RIGHTS.....	35
ARTICLE 34 - ENTIRE AGREEMENT.....	36
ARTICLE 35 - NON-EXCLUSIVE AGREEMENT .....	36
ARTICLE 36 - INDEPENDENT CONTRACTOR.....	36



ARTICLE 37 - SURVIVAL OF OBLIGATIONS..... 37  
ARTICLE 38 - LIMITATION OF LIABILITY ..... 37  
ARTICLE 39 - NOTICES..... 37

E X H I B I T S

EXHIBIT I	SCOPE OF WORKS
EXHIBIT II	EQUIPMENT, MATERIALS, SUPPLIES AND SERVICES TO BE PROVIDED BY CONTRACTOR
EXHIBIT III	CONTRACT PRICE
EXHIBIT IV	FORM OF BANK GUARANTEE
EXHIBIT V	CHANGE ORDER PROCEDURES
EXHIBIT VI	INVOICING AND ADMINISTRATION PROCEDURES/GUIDELINES
EXHIBIT VII	MUTUAL HOLD HARMLESS AGREEMENT
EXHIBIT VIII	HEALTH, SAFETY AND ENVIRONMENT REQUIREMENT

PREAMBLE

This CONTRACT (hereinafter referred to as "CONTRACT") is made and entered into this \_\_\_\_\_ day of \_\_\_\_\_ 202\_ effective as of the \_\_\_\_\_ day of \_\_\_\_\_ ("Effective Date") between

**DOMESTIC PETROLEUM OPERATING BRANCH - PETROVIETNAM EXPLORATION PRODUCTION CORPORATION LIMITED**, a company organized and existing under the Laws of S.R Vietnam and having its registered address at 15<sup>th</sup> Floor, Victory Tower, 12 Tan Trao Street, Tan My Ward, Ho Chi Minh City, S.R. Vietnam, (hereinafter referred to as "CLIENT") of the first part;

and\_

\_\_\_\_\_ a company incorporated under the laws of \_\_\_\_\_ having its registered office at \_\_\_\_\_ and place of business at \_\_\_\_\_ (hereinafter referred to as "CONTRACTOR") of the second part. (Hereinafter the parties of the first and second parts shall be referred to singularly as "Party" and collectively as "Parties").

**WHEREAS:** CLIENT is appointed as Authorized Operator's Attorney for the exploration, development and production of hydrocarbons for oil and gas fields offshore Vietnam.

**WHEREAS:** CLIENT in connection with its activities as aforesaid, desires to carry out drilling and associated operations in the Area of Operations and to enter into this Contract with CONTRACTOR for the purpose of carrying out said operations; and

**WHEREAS:** CLIENT requires the Provision ..... (hereinafter referred to as the "WORKS" or "SERVICES") as described in the **EXHIBITS** (attached hereto and made a part hereof) and in accordance with the terms of this CONTRACT;

**WHEREAS:** CONTRACTOR represents that it is able and willing to provide the aforementioned and that it has the experience and capability to do so expeditiously.

NOW, THEREFORE, for and in consideration of the mutual covenants and agreements set forth herein, the Parties hereto agree as follows:

## ARTICLE 1 - INTERPRETATION OF CONTRACT

1.1 The following documents together constitute this CONTRACT:

CONTRACT FORM ARTICLES 1 TO 39 INCLUSIVE

EXHIBIT I	SCOPE OF WORKS
EXHIBIT II	EQUIPMENT, MATERIALS, SUPPLIES AND SERVICES TO BE PROVIDED BY CONTRACTOR
EXHIBIT III	CONTRACT PRICE
EXHIBIT IV	FORM OF BANK GUARANTEE
EXHIBIT V	CHANGE ORDER PROCEDURES
EXHIBIT VI	INVOICING AND ADMINISTRATION PROCEDURES/GUIDELINES
EXHIBIT VII	MUTUAL HOLD HARMLESS AGREEMENT

In the event of any ambiguity, inconsistency or conflict between the provisions of the **CONTRACT FORM** and **EXHIBITS** listed above, the **CONTRACT FORM** shall take precedence and prevail over the **EXHIBITS**.

In the event of any ambiguity, inconsistency or conflict between the provisions of the **EXHIBITS**, **CLIENT** shall decide the order of prevalence amongst the **EXHIBITS**.

- 1.2 Any reference or details provided in any one of the above documents but not in others shall be taken as read in all documents of this CONTRACT.
- 1.3 All standards, codes, specifications, drawings, instructions, and other documents that are referred to in the **EXHIBITS** shall be deemed incorporated herein by reference and made a part of the CONTRACT.
- 1.4 None of the documents herein before mentioned shall be used by CONTRACTOR for any purpose other than for this CONTRACT.
- 1.5 Unless otherwise specified by CLIENT, any reference to time period shall be deemed to be based on calendar days.
- 1.6 All headings, indexes, titles, subtitles, subheadings, words that are bold, italic, capitalised or otherwise emphasised of the CONTRACT are used for convenience and ease of reference only and should not be taken into consideration in the interpretation or construction of the CONTRACT.
- 1.7 All correspondence, documentation, and discussion with respect to the CONTRACT and the WORKS is to be in the English Language.
- 1.8 All instructions, notifications, agreements, authorisations, approvals and acknowledgements shall be in writing (whether by mail or by fax).
- 1.9 Any review, approval, acknowledgement or certificate given by CLIENT shall not relieve the CONTRACTOR from any liability or obligation under the CONTRACT.
- 1.10 Words importing the singular only also include the plural and vice versa where the context so requires.

## ARTICLE 2 - DEFINITIONS

The following definitions shall apply to this CONTRACT except where the context otherwise requires:

- 2.1 **"Affiliate" or "Affiliated Company"** means any company or other entity that directly or indirectly through one or more intermediary controls or is controlled by or is under common control with a Party to this CONTRACT. "Control" in this context means ownership of more than fifty percent (50%) of the voting stock of the controlled company or the direct or indirect right to determine its actions by contract or otherwise.
- 2.2 **"Approved" and "Approval"** wherever used means approved and/or approval in writing including subsequent written confirmations of previous verbal approvals by (where provided for under this CONTRACT) made by CLIENT.
- 2.3 **"Area of Operations"** means those areas of the seabed and subsoil beneath the territorial waters and the continental shelf off Vietnam in which CLIENT is entitled to conduct operations relating to the exploration and production of hydrocarbons.
- 2.4 **"CLIENT"** means DOMESTIC PETROLEUM OPERATING BRANCH - PETROVIETNAM EXPLORATION PRODUCTION CORPORATION LIMITED and includes its consultants, agents, officers and employees.
- 2.5 **"CLIENT Contract Administrator"** means CLIENT's personnel as defined in ARTICLE headed as **"CLIENT'S CONTRACT ADMINISTRATOR AND REPRESENTATIVE(S)"**.
- 2.6 **"CLIENT Equipment"** means the equipment and other related parts, spares and other materials to be provided by CLIENT.
- 2.7 **"CLIENT Representative"** means CLIENT's representative as defined in ARTICLE headed as **"CLIENT'S CONTRACT ADMINISTRATOR AND REPRESENTATIVE(S)"**.
- 2.8 **"Change Order"** means a document to be issued by CLIENT which sets forth changes in the WORKS and adjustments to the CONTRACT Price or Schedule or both, and which sets forth the basis on which CONTRACTOR will be compensated for the change, if applicable.
- 2.9 **"CONTRACT"** means the terms and conditions of this **CONTRACT FORM**, and the **EXHIBITS**, references and documents attached hereto or incorporated by reference including any subsequent amendments to them.
- 2.10 **"CONTRACT Price"** means the agreed compensation to be paid to CONTRACTOR in a prescribed method as specified and qualified in **EXHIBIT III - CONTRACT PRICE**.
- 2.11 **"CONTRACTOR"** means the Party entering into the CONTRACT with CLIENT for the delivery of the performance of the WORKS or part thereof as set forth in the CONTRACT and includes the CONTRACTOR Personnel, representatives, successors and such other persons or body of persons to whom the CONTRACTOR has assigned this CONTRACT.
- 2.12 **"CONTRACTOR Contract Administrator"** means CONTRACTOR's Personnel as defined in ARTICLE headed as **"CONTRACTOR'S CONTRACT ADMINISTRATOR AND REPRESENTATIVE"**.

- 2.13 **"CONTRACTOR Representative"** means CONTRACTOR's representative as defined in **ARTICLE** headed as **"CONTRACTOR'S CONTRACT ADMINISTRATOR AND REPRESENTATIVE"**.
- 2.14 **"CONTRACTOR Equipment"** means the equipment and other related parts, spare parts, materials, tools, expendables, designated equipment and other supplies that are to be provided or supplied by CONTRACTOR as defined in **ARTICLE** headed as **"CONTRACTOR'S OBLIGATION"** and more specifically described in **EXHIBIT I – "SCOPE OF WORKS"**.
- 2.15 **"CONTRACTOR Personnel"** means all personnel provided by CONTRACTOR in the performance of the WORKS as defined in **ARTICLE** headed as **"CONTRACTOR'S OBLIGATION"** and more specifically described in **EXHIBIT I – "SCOPE OF WORKS"**.
- 2.16 **"Expert"** means a person or company mutually agreed upon by CLIENT and CONTRACTOR to give a technical opinion in order to expedite settlement of any particular matter as described in **ARTICLE** headed as **"ARBITRATION"**.
- 2.17 **"Gross Negligence"** means (i) any act or failure to act which seriously or substantially deviates from a prudent course of action or (ii) any act or omission in violation of the most elementary rules of diligence which a conscientious contractor in the same position and under the same circumstances would have followed or (iii) such wanton and reckless conduct or omission as constitutes in effect an utter disregard for foreseeable, harmful and avoidable consequences.
- 2.18 **"Specification"** means a collection of documents, standards and codes to which the WORK must conform to.
- 2.19 **"Standard"** means any description of a technical nature of materials, engineering methods and techniques, equipment, construction systems and methods, specifications, plans, workmanship or otherwise defining a result to be achieved or method to be followed.
- 2.20 **"Sub-contract"** means any contract between CONTRACTOR and any other third party or parties as approved in writing by CLIENT for the performance of any portion of the WORKS or any part thereof.
- 2.21 **"Sub-contractor"** means any third party or parties having a subcontract with CONTRACTOR as approved in writing by CLIENT for the performance of any portion of the WORKS or any part thereof.
- 2.22 **"Writing(s)"** means all printed or hand-written documentation including but not limited to all telexes, cables and similar items. All requests, approvals, notices and agreements required under this CONTRACT shall be in writing.
- 2.23 **"WORKS"** shall mean all SERVICES to be performed and rendered by CONTRACTOR or its Sub-contractor as expressly set forth in the CONTRACT and all of CONTRACTOR's activities that are reasonably inferable from the description of the WORKS. This shall include SERVICES performed pursuant to any authorisation for WORKS.
- 2.24 **"Work Sites"** shall mean the areas as designated by CLIENT where the WORKS is to be performed.
- 2.25 **"Work Order"** shall mean a document issued by CLIENT to CONTRACTOR in the format provided in **Exhibit VI** to this CONTRACT.

### ARTICLE 3 - DURATION OF CONTRACT

- 3.1 Subject to termination provision provided under **ARTICLE** headed as "**PROVISION FOR TERMINATION OF CONTRACT**", this CONTRACT shall commence on the Effective Date stipulated in the preamble and shall remain valid until the WORKS completed and CLIENT and CONTRACTOR fulfil all obligations and responsibilities under this CONTRACT.

### ARTICLE 4 - CONTRACT PRICE

- 4.1 For the satisfactory performance of the WORKS in accordance with the CONTRACT, CLIENT shall pay CONTRACTOR the lump sum amounts and/or unit rates detailed in the **EXHIBIT III - "CONTRACT PRICE"**.
- 4.2 Except as expressly provided in this Contract, the CONTRACT Price shall remain unchanged throughout the duration of this CONTRACT and shall not be subjected to change for any reason whatsoever including but not limited to cost escalation or currency fluctuations.

### ARTICLE 5 - INVOICING AND PAYMENTS

- 5.1 All invoices claimed by CONTRACTOR shall be itemized as being directly associated with the CONTRACT and shall be verified and signed by the authorized signatory prior to submission to CLIENT for payment. Invoicing for WORKS performed shall be kept current at all times.
- 5.2 Any charges made by CONTRACTOR for items reimbursable at actual cost under this CONTRACT or payments made on CLIENT's behalf shall be net of all discounts and allowances, whether or not taken by CONTRACTOR plus appropriate handling cost as specified in EXHIBIT III and be supported by sufficient documentation to fully support such reimbursement and permit verification thereof by CLIENT.
- 5.3 Invoices shall indicate the CONTRACT number and title and shall be submitted in one (1) original and one (1) copy each complete with the necessary documentation required by CLIENT and shall be addressed to:-

**DOMESTIC PETROLEUM OPERATING BRANCH -  
PETROVIETNAM EXPLORATION PRODUCTION CORPORATION  
LIMITED**

15<sup>th</sup> Floor Victory Tower, 12 Tan Trao Street  
District 7, Ho Chi Minh City, S.R Vietnam  
Attn: **Manager, Finance & Accounts**

- 5.4 Payments of undisputed invoiced items shall be made on or before the forty-fifth (45<sup>th</sup>) day after receipt thereof. If the forty-fifth (45<sup>th</sup>) day falls on a Sunday or a gazetted public holiday, the next working day shall be deemed to be the due day for payment. Payments in respect of disputed items may be withheld by CLIENT until the settlement of the dispute by mutual agreement. Payments made by CLIENT shall not preclude the right of CLIENT to thereafter dispute any of the items invoiced.
- 5.5 In the event that CLIENT disputes any items on a particular invoice CLIENT shall only be entitled to withhold from payment the actual amount in dispute. If CLIENT disputes any items on an invoice, CLIENT shall inform CONTRACTOR of the

disputed item within thirty (30) days of the receipt by CLIENT of that particular invoice.

- 5.6 CLIENT shall be entitled to withhold payment if any of CONTRACTOR's invoices do not include the supporting documentation required by CLIENT. In any case, Bank guarantee as required under Article 6 - Bank guarantee (if applicable) shall be included in the supporting documentation.
- 5.7 As a condition precedent to making any payments to CONTRACTOR, CONTRACTOR shall, if requested by CLIENT provide satisfactory evidence that the payment for all labour, materials, equipment and other obligations arising out of the performance of this CONTRACT have been fully specified and discharged.

If CLIENT receives a bona fide claim from CONTRACTOR's suppliers or Sub-contractors that they have not been paid by CONTRACTOR for WORKS done or material furnished in connection with the performance of WORKS under this CONTRACT, CLIENT shall first consult with CONTRACTOR with respect to such complaint. If after such consultation, CLIENT is of the reasonable opinion that such complaint is valid, CLIENT shall be entitled to withhold such amounts from payments due to CONTRACTOR under this CONTRACT until CONTRACTOR discharges such claims whereupon CLIENT will immediately release such sums withheld to CONTRACTOR.

- 5.8 All payments to CONTRACTOR by CLIENT under the terms of this CONTRACT shall be in Vietnam Dong (VND).
- 5.9 Upon notification of any erroneous billings made by or payments made to CONTRACTOR by CLIENT, CONTRACTOR shall within fourteen (14) days, make appropriate adjustments therein and reimburse to CLIENT any amounts of over-payment still outstanding as reflected by said adjustments. Notwithstanding the foregoing, CLIENT shall be entitled to deduct such amount from payment due to CONTRACTOR. Accordingly, CLIENT shall pay CONTRACTOR any amount of under-payment subject to verification thereof.
- 5.10 Payment made under this CONTRACT shall not preclude the right of CLIENT to thereafter dispute any of the items invoiced and shall not constitute an admission by CLIENT as to the performance by CONTRACTOR of its obligations hereunder and in no event shall any such payment affect the warranty obligations of CONTRACTOR. Any payments withheld shall be without prejudice to any other rights or remedies available to CLIENT.
- 5.11 CLIENT shall not be responsible and liable to pay any invoice(s) received later than three (3) months from CONTRACTOR after Termination of this Contract for the performance of the WORKS.
- 5.12 All invoices, financial settlements and billings by CONTRACTOR to CLIENT shall reflect properly the facts relating to all activities and transactions handled for CLIENT's account.
- 5.13 All payments to CONTRACTOR shall be made to: -

**BANK NAME AND ADDRESS:** \_\_\_\_\_  
\_\_\_\_\_

**ACCOUNT NUMBER:** \_\_\_\_\_

ARTICLE 6 - BANK GUARANTEE

- 6.1 CONTRACTOR shall furnish to CLIENT an irrevocable first call and unconditional Bank Guarantee in the format set out in EXHIBIT IV of this CONTRACT amounting to ten percentage (10%) of the Contract value, issued by a reputable bank and acceptable to CLIENT within thirty (30) days of the award of this CONTRACT to guarantee the due performance by the CONTRACTOR of its obligations under this CONTRACT. The expiry date of this Bank Guarantee shall be not earlier than 30 days after the WARRANTY period of the CONTRACT and any extension thereto. Such guarantee shall be binding notwithstanding such variation, alterations or extensions of time as may be made, given, conceded or agreed under this CONTRACT. The expense of preparing, completing and stamping such instrument shall be borne by CONTRACTOR.
- 6.2 Should the expiry date of the Bank Guarantee required to be furnished pursuant to the foregoing Clause of this Article occur before the expiry period mentioned above, the CONTRACTOR shall provide, at least fourteen (14) days before the expiry date, a fresh guarantee in the form similar to and in the amount of those previously provided, except for a revised date of expiry which shall be not earlier than 30 days after the WARRANTY period of the CONTRACT or any extension thereto. Should CONTRACTOR fail to provide the fresh guarantee as required, CLIENT shall, without prejudice to all its other rights under the CONTRACT or in law, have the right at any time to invoke the Bank Guarantee referred to in this Article 6.
- 6.3 If the Bank Guarantee to be furnished pursuant to this Article 6, is not duly furnished by CONTRACTOR to CLIENT within the above prescribed period, CLIENT may, at its option and without prejudice to any rights or claims it may have against CONTRACTOR by reason of CONTRACTOR's noncompliance with any of the provisions of this Article, withhold an amount equivalent to the payment due or becoming due to the CONTRACTOR under this CONTRACT until such time the Bank Guarantee is furnished by the CONTRACTOR, whereupon CLIENT shall immediately release such sums withheld to CONTRACTOR, or terminate this CONTRACT by notice in writing to CONTRACTOR. In the case of termination, CLIENT shall thereupon not be liable for any claim or demand from CONTRACTOR under the provisions of this CONTRACT in respect of anything then already done or furnished, or in respect of any matters or thing whatsoever in connection with or relating to this CONTRACT, but CLIENT shall be entitled to be reimbursed by CONTRACTOR for all reasonable documented expenses incurred by CLIENT in obtaining a new CONTRACTOR to perform the WORKS.
- 6.4 CLIENT reserves the right to instruct CONTRACTOR to revise the Bank Guarantee amount to correspond to any increase in the Contract Price. Failure to revise the Bank Guarantee shall constitute a failure by CONTRACTOR to perform this CONTRACT entitling CLIENT to make an immediate call on the Bank Guarantee.

## ARTICLE 7 - TAXES AND DUTIES

### **7.1 CONTRACTOR LEGAL STATUS**

#### **7.1.1 Vietnamese CONTRACTOR**

The CONTRACTOR is a Vietnamese registered business entity which is registered under Vietnamese Laws (including but not limited to, the Corporate Law, Investment Law, Petroleum Law etc.,) and applying Vietnamese Accounting System.

- 7.1.1(a) The CONTRACTOR shall be liable for and declare and pay at its own cost and cause to be paid any and all taxes and duties of whatsoever nature assessed or levied against the CONTRACTOR and its employees or agents by the competent authorities of Vietnam or any other country on account of or in relation to or in connection with the WORK.

- 7.1.1(b) The CONTRACTOR shall be liable for and pay or cause to be paid any and all taxes and duties levied or assessed against the CONTRACTOR or against the CLIENT by the competent authorities of Vietnam in respect of personal income, salaries or any other benefits of whatsoever nature paid to or received by or acquired by the CONTRACTOR's employees.
- 7.1.1(c) Notwithstanding Article 7.1.1(a), CLIENT shall pay the Value Added Tax ("VAT") amount imposing in the WORKS as stated on VAT invoice issued by the CONTRACTOR for the WORK and CONTRACTOR shall settle the VAT levied on this WORK to the relevant Tax Authorities if Vietnam.
- 7.1.1(d) The CONTRACTOR agrees to observe all laws, rules and regulations of Vietnam relating to taxes and duties, including income taxes, and including, if applicable the filing of returns, assessment of tax and keeping and showing of books and records.
- 7.1.1(e) The CONTRACTOR shall indemnify and hold the CLIENT harmless against any and all liability and claims of whatsoever nature resulting from the CONTRACTOR's failure to pay such taxes, levies and duties referred to in above Articles 7.1.1(a), 7.1.1(b) and 7.1.1(c).
- 7.1.1(f) If the CLIENT receives a notice requiring it to pay any levies, charges contributions and taxes of the type referred to in this Article 7.1 and/or any interest or penalty thereon whether with respect to the CONTRACTOR, any its Sub-CONTRACTOR or any other person employed by them or providing any services to them on or in connection with the Contract, the CLIENT shall forthwith notify the CONTRACTOR who shall cooperate with the CLIENT to make all reasonable endeavors to make any valid appeal against such payment. In the event that the CLIENT is ultimately required to make such payment, the CLIENT may recover from the CONTRACTOR any such sums and all reasonable costs incurred in connection therewith and the CONTRACTOR shall within thirty (30) days of receiving written notice from CLIENT pay to the CLIENT any such sum or CLIENT shall be entitled to deduct such sums from any monies due, or which may become due, to the CONTRACTOR.

**7.1.2 Foreign CONTRACTOR:**

The CONTRACTOR is a foreign registered business entity which is registered in any country other than Vietnam, and applying the Direct Method for Value Added Tax filings and payments pursuant to the applicable Vietnamese Tax law for Foreign CONTRACTOR

- 7.1.2(a) The CONTRACTOR shall be liable for and declare and pay at its own costs and cause to be paid any and all taxes and duties of whatsoever nature assessed or levied against the CONTRACTOR and its employees or agents by the competent authorities of Vietnam or any other country on account of or in relation to or in connection with the WORK or this Contract.
- 7.1.2(b) The CONTRACTOR shall be liable for and pay or cause to be paid any and all taxes and duties levied or assessed against the CONTRACTOR or against the CLIENT by the competent authorities of Vietnam in respect of personal income, salaries or any other benefits of whatsoever nature paid to or received by or acquired by CONTRACTOR's employees.
- 7.1.2(c) Notwithstanding Article 7.1.2(a), the following shall apply with respect to Value Added Tax ("VAT") and Corporate Income Tax ("CIT"). For the purpose of this Article 7.1.2(c), the term VAT and CIT shall have the same meaning as taxes by that name defined by the Ministry of Finance of Vietnam and the CONTRACTOR is a foreign

registered entity applying the Direct Method pursuant to the applicable Vietnamese Tax Law. The term CIT and VAT shall be extended to cover any and all taxes (with similar nature as current CIT and VAT) levied or imposed on the WORKS by Vietnam Tax Authorities, arise as a result of changes in the legislation or interpretation and application after the execution of the Contract.

- i) The CLIENT shall pay the deemed VAT and CIT, in the name of and on behalf of the CONTRACTOR, levied on the WORKS. The CONTRACTOR shall submit the invoice stating the net amount only and shall receive the net amount.
- ii) In the event that proof of payment is requested by Vietnam Tax Authorities or alternative Government agency, the CLIENT shall provide this proof of payment as required.

7.1.2(d) In those instances where the Government of the Socialist Republic of Vietnam and CONTRACTOR's Government signed a Double Taxation Agreement, CLIENT shall, on behalf of CONTRACTOR, implement the procedures on tax exemption in compliance with applicable regulation of the Ministry of Finance of the S.R Socialist Republic of Vietnam and the relevant Double Taxation Agreement. Upon CLIENT's request, CONTRACTOR shall cooperate, and assist the CLIENT in obtaining the information and documents required by law in relation to the implementation procedures on tax exemption, including but not limited to, assistance in obtaining a proper tax registration certificate issued by the competent tax authorities of the country of which the CONTRACTOR is tax resident. CONTRACTOR shall be liable for the accuracy and lawfulness of the information and documents that provided to CLIENT.

7.1.2(e) CONTRACTOR agrees to observe all laws, rules and regulations of Vietnam relating to taxes and duties, including income taxes, and including, if applicable, the filing of returns, assessment of tax and keeping and showing of books and records.

7.1.2(f) When requested by CLIENT, CONTRACTOR shall provide evidence that it has paid all personal income tax due on remuneration paid to CONTRACTOR's employee. In the event that CLIENT determines, or has reason to believe, that CONTRACTOR has not met its obligations in this regard, CLIENT shall advise CONTRACTOR accordingly in writing. In such case, any payment otherwise due to CONTRACTOR may be withheld by CLIENT until CONTRACTOR provides satisfactory evidence that it has fulfilled such obligations.

7.1.2(g) CONTRACTOR shall protect and indemnify and hold the CLIENT and any of CLIENT's Affiliate harmless against any and all liability and claims of whatsoever nature resulting from CONTRACTOR's failure to pay such taxes, levies and duties referred to in above Articles 7.1.2(a), and 7.1.2(b) and 7.1.2(c). CLIENT shall protect and indemnify and hold CONTRACTOR harmless against any and all liability and claims of whatsoever nature resulting from CLIENT's failure to pay such taxes, levies and duties referred to in above Article 7.1.2(c).

7.1.2(h) If the CLIENT receives a notice requesting it to pay any levies, charges contributions and taxes of the type referred to in this Article and/or any interest or penalty thereon whether with respect to the CONTRACTOR, any SUB-CONTRACTOR or any other person employed by them or providing any services to them on or in connection with the Contract, the CLIENT shall forthwith notify the CONTRACTOR who shall work with the CLIENT to make all reasonable endeavours to make any valid appeal against such payment. In the event that the CLIENT is ultimately required to make such payment, the CLIENT may recover from the CONTRACTOR any such sums and all reasonable costs incurred in connection therewith and the CONTRACTOR shall within thirty (30) days of

receiving written notice from CLIENT pay to the CLIENT any such sum or CLIENT shall be entitled to deduct such sums from any monies due, or which may become due, to the CONTRACTOR.

## **7.2 Personal Income Tax**

The CONTRACTOR shall be responsible to register, declare and pay to the any government authorities including but not limited to Vietnamese Tax authorities any Personal Income Tax or other statutory obligations due and payable in relation to the remuneration of all CONTRACTOR's and its sub-Contractors' Personnel. CONTRACTOR shall submit all necessary documentation (including but not limited to tax declarations, evidence of payment, tax receipt) to CLIENT to support such payment and substantiate that proper payment has been made to the Vietnamese Tax Authorities.

## **7.3 Importation and Exportation of CONTRACTOR's Material and Equipment**

- 7.3.1 CONTRACTOR shall at its own expenses be responsible for all customs duties, licenses, fee, import or tariffs or similar charges imposed by the Government of Vietnam or any other countries, states or relevant authorities which the CONTRACTOR is obligated to pay in relation to CONTRACTOR's associated Materials and Equipment imported into the Socialist Republic of Vietnam for performance of the WORKS.
- 7.3.2 CONTRACTOR shall be responsible for the preparation of all documents required by Customs Authorities in connection with the import and export of CONTRACTOR Equipment to and from the Socialist Republic of Vietnam.
- 7.3.3 Notwithstanding the fact that CONTRACTOR Equipment is imported in the name of CLIENT, CONTRACTOR shall remain responsible for such equipment while in the Socialist Republic of Vietnam. CONTRACTOR shall protect, indemnify and hold harmless CLIENT from and against any claims, demands and causes of action, which may arise as a result of damage to, shortages, or overages in inventory of such equipment.
- 7.3.4 Upon termination of this CONTRACT or the operation involving the use of such CONTRACTOR Equipment, whichever occurs first, CONTRACTOR shall take immediate steps to remove such equipment from the Socialist Republic of Vietnam other than equipment used or consumed in the performance of the WORKS. Unless CLIENT agrees otherwise in writing, CONTRACTOR shall comply with all directions and procedures as required by CLIENT to cause such equipment to be removed as expeditiously as possible.
- 7.3.5 CONTRACTOR shall indemnify and hold CLIENT harmless from and against any and all taxes, duties, surcharges, fines, or penalties of whatsoever nature for which CLIENT shall be or become liable as a result of CONTRACTOR's failure to comply with the directions and procedural requirements of CLIENT with respect to the removal of CONTRACTOR Equipment imported in CLIENT's name or as a result of CONTRACTOR's act in selling, transferring, disposing, or otherwise dealing with such equipment prior to its removal from the Socialist Republic of Vietnam or as a result of CONTRACTOR's failure to furnish proper and accurate information for import of such equipment.
- 7.4 Without prejudice to **ARTICLES 7.1, 7.2 and 7.3** CONTRACTOR shall protect and indemnify CLIENT and hold CLIENT safe and harmless from any and all claims or liability for income, excess profits, royalty, and other taxes assessed or levied by the Government of any country against CONTRACTOR or its Sub-contractors or against CLIENT for or on account of any payment made to or earned by CONTRACTOR or its Sub-contractors hereunder. CONTRACTOR further shall protect and hold CLIENT harmless from all taxes assessed or levied against or on account of wages, salaries, or other benefits paid to or enjoyed by employees of CONTRACTOR or its Sub-contractors, and

from all taxes assessed or levied against, on, or for account of any property or equipment of CONTRACTOR or its Sub-contractors.

- 7.5 CLIENT shall herein have the right to withhold including but not limited to income, excess profit, royalty, and other taxes from payment due to CONTRACTOR under this CONTRACT, to the extent that such withholdings shall be required by the Government Authorities of any country including the Vietnamese Government Authorities. Payment by CLIENT to the respective governmental office of the amount of money so withheld shall relieve CLIENT from any further obligation to CONTRACTOR with respect to the amount so withheld.
- 7.6 CONTRACTOR shall indemnify CLIENT against all claims, demands and causes of action based on any actual or alleged failure by CONTRACTOR or its Sub-contractors to make timely payment of any taxes or duties for which they are liable or any actual or alleged failure by CONTRACTOR or its Sub-contractors to comply with applicable reporting, return, or other procedural requirements with respect to their payment to any Government authorities of any country including the Vietnamese Government Authorities. This indemnity shall include, without limitation, all penalties, awards and judgments, court and arbitration costs, attorneys' fees, and other reasonable expenses associated with such claims, demands, and causes of action.
- 7.7 For the purpose of **ARTICLE 7** only, the expression "tax" shall mean, where the context so admits, any tax, duty or charge, including any additional charge or interest, assessed or levied by the appropriate Vietnamese Government Authority in respect of the CONTRACT.
- 7.8 CONTRACTOR shall give prompt notice to CLIENT of all matters pertaining to non-payment, claims of immunity, or exemption from any taxes or duties.

#### ARTICLE 8 - INSURANCE

- 8.1 CONTRACTOR shall at its own cost and expense carry and maintain in full force throughout the duration of this CONTRACT at least the following insurances with companies satisfactory to CLIENT. Nothing contained herein shall serve in any way to limit or waive CONTRACTOR's responsibility under this CONTRACT. The insurances to be carried by CONTRACTOR are as follows:
- (a) **Workmen's Compensation and/or Employer's Liability Insurance or similar statutory social insurance** as required by law at the Work Site where the WORKS will be performed and which may be applicable covering all CONTRACTOR'S employees engaged in accomplishing the WORKS.
- (b) **Comprehensive General Third Party Liability Insurance** covering all operations hereunder against bodily injury, death, loss of, or property damage with minimum limits of **United States Dollars One Million (USD 1,000,000)** or equivalent value in other currency for any one occurrence and unlimited as to the number of claims in the period of insurance. Such insurance shall include Contractual Liability coverage.
- (c) **Any other insurance** which may be relevant and/or necessary and/or as may be required by any law(s) to which the CONTRACTOR and/or Sub-contractors are subjected to.
- 8.2 To the extent of indemnities given by CONTRACTOR herein, CONTRACTOR shall cause CLIENT and Co-Venturers, their parent companies, subsidiaries, Affiliates, consultants and their respective agents, officers and employees to be included as additional assured and

to be covered by all insurances as stipulated in **ARTICLE 8.1** with respect to operations conducted under this CONTRACT and shall cause the insurers thereof to waive all expressed or implied rights of subrogation against such Parties and their respective employees, servants and agents.

CONTRACTOR shall cause the insurers thereof and of any other policy of insurance carried by CONTRACTOR including insurance covering CONTRACTOR Equipment and materials used in the performance of the WORKS to waive all expressed or implied rights of subrogation against such Parties and their respective employees, servants and agents.

- 8.3 All deductibles, exceptions, and exclusions applicable to the foregoing insurances resulting from any act or omission of CONTRACTOR shall be for the account of and be paid by CONTRACTOR. Any breach of conditions and/or warranties contained in such policies of insurances shall also be for the account of CONTRACTOR.
- 8.4 CONTRACTOR shall fully indemnify CLIENT against loss or damage arising out of any failure to effect or maintain such insurances specified by this CONTRACT or out of any act or omission which invalidates the said insurances.
- 8.5 CONTRACTOR shall within thirty (30) days of the award of this CONTRACT furnish to CLIENT certified copies of certificates of insurance provided for in **ARTICLE 8.1** hereof. No insurance shall be materially changed or cancelled while the WORK is in progress without prior written approval by CLIENT. Policies and/or extension certificates or documents shall be furnished to CLIENT. If requested by CLIENT, CONTRACTOR shall permit CLIENT to examine copies of its and its Sub-contractors original insurance policies and current premium receipts.
- 8.6 The furnishing of certificates of insurances shall not be interpreted as implying endorsement by CLIENT or that CLIENT assumes responsibility for the accuracy and adequacy of such documents or that the CONTRACTOR has complied with its other obligation contained in the CONTRACT.
- 8.7 Should CONTRACTOR at any time neglect or refuse to provide or renew any insurance required herein, or should any insurance be cancelled, CLIENT shall upon notification to CONTRACTOR have the right to procure such insurance and, in such event, any sum so paid by CLIENT shall immediately become due and payable to CLIENT by CONTRACTOR or CLIENT shall be entitled to deduct such sums from any moneys due or which may become due to CONTRACTOR in addition to any other remedies CLIENT may have under this CONTRACT.
- 8.8 CONTRACTOR shall notify CLIENT immediately upon receipt of any notice of claims, incidents, or demands or of any situation which may give rise to such claims or demands being made under the said policies. Written notice shall be given not later than two (2) days after the occurrence of any accident. However, for serious accidents (including but not limited to death or serious injuries) notice shall be given immediately and must be confirmed in writing.
- 8.9 CONTRACTOR shall ensure that its Sub-contractors maintain similar insurance coverage as specified herein and that its Sub-contractors similarly indemnify and hold CLIENT harmless against all costs, claims, and demands. Any deficiencies in the coverage or policy limits of Sub-contractor's insurance shall be for the sole responsibility of CONTRACTOR.
- 8.10 The amounts of CONTRACTOR furnished insurance called for herein shall be the minimum and not the maximum limits of liability. CONTRACTOR may provide other insurance coverage or higher limits of coverage. CLIENT will bear no financial liability attributable to deficient insurance coverage by CONTRACTOR.

- 8.11 CONTRACTOR shall not commence the shipment of equipment and materials or commence WORKS until all the insurances that CONTRACTOR is required to provide are in full force.

## ARTICLE 9 - LIABILITIES AND INDEMNITIES

### 9.1(a) **Personnel of CONTRACTOR**

CONTRACTOR shall be responsible for and shall protect, defend, indemnify and hold harmless CLIENT, its other contractor(s), its Co-venturers and Affiliates, and its and their officers, director, agents, employees and representatives from and against any and all claims, liabilities, costs, damages and expenses of every kind and nature, with respect to injury or death of or damage to or loss of property of CONTRACTOR's, Affiliates' or Subcontractors' personnel arising during and/or as a result of the performance of this CONTRACT.

### 9.1(b) **Personnel of CLIENT**

CLIENT shall be responsible for and shall protect, defend, indemnify and hold harmless CONTRACTOR, its Subcontractors and Affiliates, and its and their officers, directors, agents, employees and representatives from and against any and all claims, liabilities, costs, damages and expenses of every kind and nature, with respect to injury or death of or damage to or loss of property of CLIENT, CLIENT's, its other contractor(s) of any tier, its Affiliates' or its co-venturers' personnel and its and their invitees, arising during and/or as a result of the performance of this CONTRACT.

### 9.2 **Third Party**

Unless otherwise expressly provided for in this Contract, each Party shall be solely responsible for its own liability (including that of its Subcontractors and/or agents and/or employees) in respect of third party damages and shall hold the other Party harmless from and against any such liability.

### 9.3(a) **CONTRACTOR's Equipment and Property**

Save as otherwise expressly provided in this Contract, CONTRACTOR shall assume the risk of, and shall be solely responsible for and in this regard shall indemnify, defend and hold CLIENT, its other contractor(s) of any tier, its co-venturers and Affiliates, and its and their officers, directors, agents employees and representatives harmless from and against any claims arising out of the damage to, the loss, or destruction of, all CONTRACTOR's Equipment and property and those of CONTRACTOR's Affiliates and Subcontractors in relation to this Contract.

### 9.3(b) **CLIENT's Equipment and Property**

CLIENT shall assume the risk of, and shall be solely responsible for and in this regard shall indemnify, defend and hold CONTRACTOR, its Subcontractors and Affiliates and its and their officers, directors, agents, employees and representatives harmless from and against any claims arising out of the damage to, the loss, or destruction of, all CLIENT, its other contractor(s) of any tier, its Affiliates or its co-venturers, and its and their invitees, equipment and property (including damage to or loss of the hole or well and all well control efforts) in relation to this CONTRACT.

### 9.4 **Pollution and Contamination**

Notwithstanding anything to the contrary contained herein, CONTRACTOR shall be responsible for and hold harmless and indemnify CLIENT against all claims, cost, expenses, actions, proceedings, suits, demands and liabilities whatsoever arising out of actual or potential pollution damage and the cost of cleanup or control which cause or allow discharge, spills or leaks from substances of CONTRACTOR under this CONTRACT.

- 9.5 Except as otherwise provided in this **ARTICLE**, the indemnities given by the CONTRACTOR shall not be reduced by reasons of any negligence or omission of CLIENT Representative in failing to supervise or control the CONTRACTOR's site operations or methods of working or to detect or prevent or remedy defective WORKS or to ensure proper performance of any other obligations of the CONTRACTOR under this CONTRACT.
- 9.6 Except as expressly provided herein, CONTRACTOR shall be solely responsible for the costs of all loss or damage caused by the wilful misconduct, act, omission or negligence of CONTRACTOR.
- 9.7 CONTRACTOR shall notify CLIENT immediately of any incident, claims or litigation affecting the provisions of this **ARTICLE**.
- 9.8 **Mutual Hold Harmless Agreement**

In order to avoid disputes regarding to liability for personal injury or death of employees or for loss of or damage to property, CONTRACTOR agrees to enter into the Mutual Hold Harmless Agreement in a form substantially similar to one in Exhibit VII hereto between CONTRACTOR and the various contractors and sub-contractors of CLIENT.

#### ARTICLE 10 – ACCEPTANCE OF WORKS

- 10.1 All WORKS under this CONTRACT shall be performed in accordance with this CONTRACT to the satisfaction of the CLIENT representative.
- 10.2 Pursuant to this Article, CLIENT Representative shall, decide on all matters as to the performance and fulfilment of the CONTRACT and his decision thereon shall be final and conclusive.
- 10.3 Notwithstanding the above, acceptance of WORKS or part thereof or approval of CONTRACTOR's activities for the WORKS or partial payments made to the CONTRACTOR shall not relieve CONTRACTOR of any of its obligations and/or liabilities provided in this CONTRACT.

#### ARTICLE 11 - WARRANTY

- 11.1 CONTRACTOR warrants and guarantees that the WORKS shall be performed in a professional manner in accordance with good and sound offshore engineering and industry practices and with the requirements and conditions of this CONTRACT.
- 11.2 CONTRACTOR warrants that the design, equipment and products supplied under this CONTRACT comply with the technical specifications, are free from defects in materials, free from defects in workmanship, fit and suitable for the purpose and use for which they are intended as stated in this CONTRACT.

- 11.3 Notwithstanding anything contrary under this CONTRACT, if the defects appear within the warranty period as described above, CLIENT shall notify CONTRACTOR of the defects. At CLIENT's option, CLIENT may instruct CONTRACTOR to repair or replace or remedy the defective WORKS at no charge to CLIENT. Alternatively, CLIENT may repair or replace or remedy the defective WORKS and any/all expenses incurred by CLIENT for such repair or replacement or remedy work shall be reimbursed by CONTRACTOR.
- 11.4 The scope of CONTRACTOR's warranty shall cover all expenses incurred in the repair, replacement of all materials and equipment found to be defective, labour and all direct cost and remedy of the defective WORKS.
- 11.5 CONTRACTOR shall obtain from its Sub-contractors for assignment to CLIENT the best possible warranties and guarantees with respect to materials and workmanship of third party installed by CONTRACTOR. In the event that CONTRACTOR obtains more favourable warranties from its sub-suppliers and suppliers than those in this Article, such warranties shall be assigned to CLIENT.
- 11.6 CLIENT's inspecting, testing, witnessing tests, paying invoices or issuing any final acceptance shall not relieve CONTRACTOR from its warranty obligations set forth in this Article.
- 11.7 If CONTRACTOR fails to do the WORKS or part thereof, or make good the defect or deficiency as required by CLIENT within the specified period after delivery of written notice to CONTRACTOR by CLIENT, CLIENT shall be entitled to have the WORKS or part thereof, or the defect or deficiency or part thereof, as the case may be, carried out by its own personnel or by other contractor appointed by CLIENT. If the WORKS or the part thereof is WORKS, or the defect or deficiency or part thereof had been rectified in which CONTRACTOR should have carried out at CONTRACTOR's own cost, CLIENT shall, in addition to its right to invoke any Bank Guarantee which may have been furnished by the CONTRACTOR, be entitled to recover from CONTRACTOR the total cost to CLIENT thereof or may deduct the same from any moneys or payment due or which may become due to CONTRACTOR and if there are no or insufficient moneys available, CONTRACTOR shall reimburse CLIENT within thirty (30) days after invoicing for all such costs. In any events, CONTRACTOR shall guarantee the WORKS in the same term provided in the foregoing Articles.

#### ARTICLE 12 - CONTRACTOR'S OBLIGATION

- 12.1 CLIENT shall, without prejudice to its rights under **ARTICLE 21 – “PROVISION FOR TERMINATION OF CONTRACT”** have the right to monitor and review, from time to time, the CONTRACTOR's performance of the WORKS under this CONTRACT and CONTRACTOR's compliance with its obligations hereunder.
- 12.2 CONTRACTOR shall perform the WORKS in strict compliance with the provisions of this CONTRACT including all **EXHIBITS** attached hereto and shall comply with and adhere strictly to CLIENT's instructions and directions on any matter concerning the WORKS. The foregoing shall not however be construed to exclude CONTRACTOR's duty to exercise diligence and to perform the WORKS in accordance with the warranty set forth in **ARTICLE 11 – “WARRANTY”** hereof.
- 12.3 CONTRACTOR shall carry out all of its obligations under the CONTRACT and shall execute the WORKS with all due care and diligence and with the skill to be expected of a reputable contractor experienced in the types of work to be carried out under the CONTRACT.

- 12.4 CONTRACTOR shall take full responsibility for the adequacy, stability and safety of all operations and methods necessary for the performance of the WORKS and shall comply with the Article 18 of CONTRACT.
- 12.5 CONTRACTOR shall furnish the equipment, materials, and supplies and the necessary personnel required to perform the WORKS as specified in the **EXHIBITS** attached hereto.
- 12.6 CONTRACTOR shall commence the WORKS as instructed by CLIENT.
- 12.7 CONTRACTOR shall observe all plans, programs, specifications, schedules, and instructions provided or made by CLIENT for carrying out the WORKS.
- 12.8 During the progress of the WORKS performed hereunder, CONTRACTOR shall ensure that its personnel keep the designated area of the Work Site(s) clean and orderly at all times and shall dispose of trash and spoil as instructed by CLIENT.
- 12.9 **CONTRACTOR Furnished Equipment, Materials, and Supplies**

12.9.1 CONTRACTOR shall at its own cost furnish, install, maintain in good working order, and repair and replace where necessary throughout the duration of this CONTRACT, relevant and adequate equipment, materials and supplies for full and proper performance of the WORKS, and shall carry all spare parts and supplies as required for maintenance and good working condition of CONTRACTOR Equipment.

12.9.2 CONTRACTOR shall ensure that all materials, tools, equipment and other items used in the WORKS, whether purchased, rented, or otherwise provided by CONTRACTOR, are properly packed and equipped with proper and acceptable slings and spreader bars, where required, and that the equipment are in a safe, sound and good condition and capable of performing the functions for which they are intended; and are properly stored and protected against all-weather elements that may be detrimental to the eventual performance of the equipment if no such protection is provided.

12.9.3 For equipment assigned to the WORKS, the CONTRACTOR must indicate on the proforma invoice that is submitted to CLIENT, at time of delivery of the equipment to the Supply Base, the description, the serial number of the equipment, maintenance record, year of manufacture and/or year of purchase, with documental support.

The proforma invoice must reach CLIENT at least one day prior to the actual shipment. All items delivered must be accompanied by CONTRACTOR's Delivery Order and must be clearly tagged for material identification.

12.9.4 If any tool or other item of equipment is, in the judgement of CLIENT, unsafe or incapable of doing the functions for which it is intended, CONTRACTOR shall repair or replace the same with a safe and capable tool or item of equipment at CONTRACTOR's expense.

12.9.5 CLIENT shall have the right to inspect CONTRACTOR Equipment at any time to observe their condition. If CLIENT notifies CONTRACTOR of any defects thereto, CONTRACTOR shall take immediate steps to rectify the said defects at its own cost. However, such inspection by CLIENT shall not imply any acceptance of the condition of the said CONTRACTOR Equipment by CLIENT and CONTRACTOR shall not be relieved of its obligations under this CONTRACT by any such inspection.

12.9.6 CONTRACTOR shall keep and maintain up-to-date records of all CONTRACTOR Equipment reflecting their conditions and quantity and shall make such records available to CLIENT whenever requested.

12.9.7 CONTRACTOR agrees to visually inspect all CLIENT Equipment and materials furnished by CLIENT and shall report to CLIENT of any apparent defects therein. CONTRACTOR's use of such materials without so notifying CLIENT shall be deemed to be conclusive evidence that such materials are free from apparent defects. CLIENT Equipment on board the Drilling Rig shall be maintained in good condition and repaired by CONTRACTOR utilising CONTRACTOR Personnel provided CLIENT shall, at its costs, provide all spare parts and materials required to maintain or repair CLIENT Equipment.

12.10 **CONTRACTOR'S Personnel**

12.10.1 CONTRACTOR shall furnish at its sole risk and expense and under its exclusive direction, control and responsibility, properly qualified personnel to perform the WORKS. CONTRACTOR shall at CLIENT's cost furnish additional personnel as CLIENT may, from time to time, request in writing.

CONTRACTOR shall furnish at its sole expense any and all visas and work permits or other permits required for its personnel.  
CONTRACTOR shall furnish additional personnel as CLIENT may request in writing from time to time.

12.10.2 All CONTRACTOR Personnel directly involved in the performance of the WORKS offshore shall have undergone the necessary basic safety training required by CLIENT's and shall possess a valid Offshore Safety Certificates. All related costs with respect to getting Offshore Safety Certificates for CONTRACTOR Personnel shall be at CONTRACTOR's own expenses.

12.10.3 **Discipline**

In the performance of the WORKS, CONTRACTOR shall maintain strict discipline and good order among its employees and CONTRACTOR'S and Sub-contractor's employees and shall not permit any of them to engage in any activities that might, in CLIENT's opinion, be contrary or detrimental to the performance of the WORKS or the interests of CLIENT.

12.10.4 **Alcohol And Drug Use**

a) CONTRACTOR is responsible to ensure that its employees, agents, and Sub-contractors, its servants and its third party shall not use, be in possession or under the influence of any drug during the performance of the WORKS, or cause any drugs to be carried into the Work Site(s).

b) CONTRACTOR shall also ensure that its employees, agents, Sub-contractors, its servants and third party shall not use or be in possession of, distribute or engage in the sale of alcohol/alcoholic beverages at Work Site.

c) Any of the CONTRACTOR's personnel, employees, agents Sub-contractors and third party who is incapable of performing his work or duties due to the influence of alcohol, will be refused entry into or removed from the Work Site. CONTRACTOR shall replace such person immediately in accordance with the provision herein contained. Any cost incurred shall be for the CONTRACTOR's account.

12.10.5 **Replacement of CONTRACTOR Personnel**

(a) CONTRACTOR shall employ on the WORKS only competent and skilled personnel. Subject to all other provisions of this ARTICLE, CONTRACTOR shall ensure

that all such personnel continue in the functions and responsibilities to which they are initially assigned for as long as is necessary to achieve proper completion of the WORKS. CONTRACTOR shall not change the personnel assigned to perform the WORKS without prior approval from CLIENT in writing.

CONTRACTOR shall also take steps to ensure that in the event of a replacement, the replacement personnel shall be competent, skilled and familiar with the WORKS. Such steps shall include the training of the "would be" new personnel to take-over the work at no additional cost to CLIENT and shall include an appropriate hand over period for the replacement personnel.

(b) CLIENT shall be entitled to, without prejudice to any other rights or remedies available to CLIENT under this CONTRACT or otherwise in law, to object and require CONTRACTOR to remove from the WORKS and/or replace any of CONTRACTOR Personnel who, in the opinion of CLIENT, is incompetent, misconduct himself, is negligent in the performance of his duties, and/or violates CLIENT's alcohol/drug policy.

In such event, CONTRACTOR shall forthwith remove such person from the WORKS and such person shall not be re-employed in the WORKS again without the written permission of CLIENT. CONTRACTOR shall immediately replace, at CONTRACTOR's sole expense, any discharged person with a suitably qualified and experienced person acceptable to CLIENT.

In the event CONTRACTOR is unable to comply with these obligations, CLIENT shall have the option to terminate this CONTRACT.

**12.10.6 Language Requirement**

CONTRACTOR shall ensure that the personnel provided pursuant to this CONTRACT are competent, efficient and have adequate command of the English Language.

**12.10.7 Personnel Policies**

CONTRACTOR shall maintain good site housekeeping and shall furnish where applicable, to its personnel safety equipment including but not limited to safety helmets, safety shoes, safety harness and eye and ear protection.

CONTRACTOR shall be responsible for maintaining and enhancing the safety awareness of its personnel and Sub-contractor's personnel including arranging safety meeting and emergency drills.

CONTRACTOR shall establish and have its own written policy, safety rules and regulations for its employees and the employees of any of its Sub-contractors and shall also acquaint CLIENT Representative with the same.

12.11 At all times, CONTRACTOR shall respond promptly and shall accurately furnish to CLIENT information about the WORKS as requested.

12.12 In the execution of the WORKS, no persons other than the authorised employees or agents of the CONTRACTOR and the employees or agents of CLIENT, shall be allowed on the Work Site without the written consent of CLIENT.

12.13 Before commencing any hazardous work operations, CONTRACTOR shall inspect the Work Site and equipment involved to ensure that the WORKS will be performed under safe conditions acceptable to CLIENT. CONTRACTOR shall verify that "Work Permits" or "Certificates" are obtained prior to initiating any hazardous work.

- 12.14 CONTRACTOR shall at no cost to CLIENT be responsible for the medical welfare of its own and Sub-contractor's employees and shall take care of periodical medical examinations, arrangements for medical attendance, treatment or hospitalisation if and when necessary and will arrange suitable insurance coverage for such contingencies. In cases of emergency, CLIENT may make or provide for, the necessary emergency arrangements, the costs of which shall be reimbursed to CLIENT by CONTRACTOR.
- 12.15 CONTRACTOR shall advise CLIENT immediately in writing of any labour dispute or anticipated labour dispute, which may be expected to affect the CONTRACTOR's performance of the WORKS.
- 12.16 CONTRACTOR shall promptly review the information, data, drawings and specifications provided by CLIENT and shall immediately bring to the attention of CLIENT all things which in CONTRACTOR's opinion appear to be deficiencies, omissions, contradictions or ambiguous in such information, data, drawings or specifications.
- 12.17 In addition to all legal and specific requirements stated herein, CONTRACTOR and CONTRACTOR's agents, employees, representatives and Sub-contractors who are engaged in the performance on the WORKS shall comply with, abide by and enforce at its sole expense any rules, regulations and standards on safety, fire protection and security regulations as set forth by CLIENT in its safety manuals, policies and special instructions.
- 12.18 CONTRACTOR shall ensure that all its employees, agents and Sub-contractors comply with CLIENT's rules, regulations, practices and requirements in the area of CLIENT's operations. This shall not relieve CONTRACTOR of its obligations as stipulated herein and in particular this **ARTICLE**.

#### ARTICLE 13 - CLIENT'S OBLIGATION

- 13.1 CLIENT will, but is not obliged to, provide assistance to the CONTRACTOR in securing necessary permits or data from Vietnam governmental authorities and/or agencies when required under this CONTRACT. However, failure by CLIENT to obtain and provide such assistance shall not relieve the CONTRACTOR from its obligation to secure the same at its own costs.
- 13.2 The signing, countersigning or other endorsements of any Drawings and documents by CLIENT, its agents or employees shall not be interpreted as implying that CLIENT, its agents or employees assume the responsibility for the correctness of such documents nor relieving the CONTRACTOR of its obligations to review all information, data, Drawings, Documents and Specifications provided by CLIENT.

#### ARTICLE 14 - ACTIONS ON BEHALF OF CLIENT

- 14.1 CONTRACTOR shall take no action on behalf of CLIENT in the performance of the WORKS, which would subject either Party to liability or penalty under any laws, rules, regulations, or decrees of any relevant authority.
- 14.2 CONTRACTOR shall have no authority to and shall not make any statements, representations or commitments of any kind or to take action which shall be binding upon CLIENT, except as provided for herein or otherwise authorised in writing by CLIENT.
- 14.3 CONTRACTOR is an independent CONTRACTOR and neither CONTRACTOR nor CONTRACTOR's respective employees are deemed to be agents or employees of CLIENT.

- 14.4 CONTRACTOR shall notify CLIENT promptly upon discovery of any instance where CONTRACTOR has not complied with the requirements of this **ARTICLE**.

ARTICLE 15 - CLIENT'S CONTRACT ADMINISTRATOR AND REPRESENTATIVE(S)

The following defined CLIENT Contract Administrator and Representative(s) shall be designated in **EXHIBIT I – SCOPE OF WORKS**. Notice of any change shall be given by CLIENT to CONTRACTOR in writing.

15.1 **CLIENT Contract Administrator**

CLIENT Contract Administrator is the person who shall be responsible for and is duly authorised to receive and act on behalf of CLIENT on all matters pursuant to the terms and conditions of this CONTRACT. The CLIENT Contract Administrator shall have the authority to make the final decisions for CLIENT on all questions, controversies, or disputes involving the interpretation and implementation of this CONTRACT.

15.2 **CLIENT Representative(s)**

The CLIENT Representative shall have the right to receive all information pertaining to records, reports, and any other information pursuant to the WORKS and **EXHIBITS** attached hereto.

CLIENT Representative(s) shall have the right to issue instructions with respect to the CONTRACT, reject or disapprove of any part of the WORKS, which does not conform to this CONTRACT, and to decide on all matters or questions which may arise relating to the performance of the WORKS and his decision shall be final and conclusive.

CLIENT Representative(s) shall be entitled to inspect all WORKS performed hereunder and to witness and to check all tests on CONTRACTOR Equipment. Notwithstanding the above, the presence of and the inspection by CLIENT Representative(s) shall not relieve CONTRACTOR from CONTRACTOR's obligations and duties and shall not prejudice CLIENT's rights under this CONTRACT.

CLIENT Representative(s) shall consult with CONTRACTOR Representatives in delivery of Goods or planning and co-ordinating the WORKS, and all instruction(s) given by CLIENT Representative(s) consistent with the provisions of this CONTRACT shall be deemed those of CLIENT and shall be complied with by CONTRACTOR.

ARTICLE 16 – CONTRACTOR'S CONTRACT ADMINISTRATOR AND REPRESENTATIVE

The following defined CONTRACTOR Contract Administrator and CONTRACTOR Representative shall be designated in **EXHIBIT I –SCOPE OF WORKS**. Notice of any change shall be given by CONTRACTOR to CLIENT in writing.

16.1 **CONTRACTOR CONTRACT Administrator**

CONTRACTOR Contract Administrator is the person who shall be responsible for and is duly authorised to represent CONTRACTOR at all times during the progress of the WORKS and to receive and to act on any request made by CLIENT in the performance of the WORKS pursuant to the terms of this CONTRACT.

CONTRACTOR Contract Administrator shall have full authority concerning the performance of the WORKS and shall have full authority to proceed with the WORKS and every part thereof in conformity with this CONTRACT. CLIENT shall be entitled to rely on all decisions and positions of the CONTRACTOR Contract Administrator as those of CONTRACTOR.

16.2 **CONTRACTOR Representative(s)**

CONTRACTOR Representative is the person employed by CONTRACTOR who will have supervisory authority over the WORKS and with whom CLIENT Representative(s) may plan and co-ordinate the performance of the WORKS. Notice concerning operations, which are transmitted to CONTRACTOR through its designated CONTRACTOR Representative(s) will be deemed, for the purpose of this CONTRACT, to have been sufficiently given.

**ARTICLE 17 - LIENS AND CLAIMS**

- 17.1 CONTRACTOR shall indemnify and hold CLIENT harmless from and shall keep CONTRACTOR Equipment, CLIENT Equipment, wells, and the WORKS free of all liens, claims, assessments, fines, and levies created, caused, or committed by CONTRACTOR or its Sub-contractors and all costs, damages, and expenses incidental thereto; including without limitation all court and arbitration costs, legal fees, and other reasonable expenses. CONTRACTOR shall notify CLIENT of such liens and/or claims.
- 17.2 CLIENT shall have the right to retain from any payment to be made under this CONTRACT an amount sufficient to offset such liens and/or claims which CONTRACTOR fails to discharge promptly until such lien and/or claim is proven to be invalid or is satisfied, discharged, or settled.
- 17.3 Should there be any liens and/or claims after all payments hereunder have been made, CONTRACTOR agrees to refund to CLIENT upon demand all moneys that CLIENT may be compelled to pay to discharge any such liens and/or claims in consequence of CONTRACTOR's default including all costs and legal and professional fees.
- 17.4 At the completion of the WORKS hereunder, or upon expiry or earlier termination of this CONTRACT, CONTRACTOR shall submit to CLIENT a 'CONTRACT CLOSURE LETTER' and 'CONTRACT CLOSURE CERTIFICATE' as per format in the **EXHIBIT VI - "INVOICING AND ADMINISTRATION PROCEDURES/GUIDELINES"** stating that all of CONTRACTOR's employees, Sub-contractors and suppliers have been paid in full, for WORKS done or for equipment, materials and supplies furnished to, and all debts, taxes, liens, privileges, claims, charges, and obligations arising out of the purchase or lease of equipment, materials, supplies, and labour for use in the WORKS hereunder to the date of such statements in connection with the performance of the WORKS have been fully and finally paid. In the event of any dispute, CONTRACTOR shall post a bond, or any other form of security acceptable to CLIENT, to secure or insure CLIENT against any such liens and/or claims.
- 17.5 Such affidavit shall ensure immunity to CLIENT from all liens and/or claims for which CLIENT might be or become liable. CONTRACTOR shall indemnify and hold CLIENT harmless from and against all claims, demands, damages, losses, costs, proceedings, charges, and expenses arising out of or incurred in connection with any claims or liens asserted by CONTRACTOR's Sub-contractors, suppliers, or any other liens and claims arising out of the performance of this CONTRACT by CONTRACTOR.

A

## ARTICLE 18 - SAFETY, HEALTH, ENVIRONMENT

### 18.1 LAWS AND REGULATIONS

- 18.1.1 CONTRACTOR shall comply with all laws, regulations, and requirements pertaining to **safety, health, fire, environmental protection, and security regulations**, which are applicable to the location where the WORK is being carried out.
- 18.1.2 CONTRACTOR shall ensure its personnel employed for the WORKS comply at all times with the requirements as set forth by CLIENT in its HSE Manuals, Safety Manual, policies, procedures, any special instructions, and all requirements of CLIENT.
- 18.1.3 CONTRACTOR shall ensure that all services, materials, and CONTRACTOR's items used in the performance of the WORKS comply with the above laws, regulations, and requirements and otherwise meet generally accepted industry standards for occupational health, safety and environment.
- 18.1.4 Upon termination of the CONTRACT, CONTRACTOR shall within sixty (60) days deliver to CLIENT a satisfactory CONTRACT CLOSE-OUT REPORT in a format and meeting such technical content as specified by CLIENT.

### 18.2 SAFETY EQUIPMENT

CONTRACTOR shall, where applicable, provide at its own expense adequate first aid, fire-fighting, lifesaving, and other safety equipment of approved types and amount as may be specified in connection with this CONTRACT and shall maintain this equipment in a professional manner and, where appropriate, re-certify the said safety equipment as dictated by legal and industry standards.

CONTRACTOR shall keep up-to-date records of all said equipment, including equipment location plans.

CONTRACTOR shall ensure that all cargo and items of equipment located at Work Site and at CONTRACTOR's onshore base are stored in a proper and safe manner and that CONTRACTOR's equipment is in all respects fit and suitable to undertake any operations.

CONTRACTOR shall also, at its own expense, be responsible for providing its personnel with personal protective equipment as required by CLIENT.

### 18.3 SAFETY PROCEDURES AND MANUALS

CONTRACTOR shall have in place, prior to commencement of this CONTRACT, a written Safety Manual and Emergency Response Manual duly endorsed by CONTRACTOR's Management and approved by CLIENT.

### 18.4 CERTIFICATION OF PERSONNEL

CONTRACTOR shall ensure that all machineries, equipment, and tools are operated by competent personnel who are fully trained and certified to carry out the task. The said personnel shall be authorised in writing by CONTRACTOR's Management or certified by a reputable training establishment acceptable to CLIENT.

### 18.5 RIGHT TO STOP WORK

CLIENT Representative shall have the right, but not the obligation, to prohibit the commencement of the WORKS or to stop any part of the WORKS in progress if the equipment, personnel, or work conditions are considered to be unsafe or not in compliance with CLIENT's rules and regulations.

18.6 **WEATHER/SEA CONDITION**

CONTRACTOR may suspend any part of the WORKS under this CONTRACT at any time with CLIENT's prior approval because of dangerous weather or sea conditions or other reasons relating to safety. Similarly, if requested to do so by CLIENT in writing, CONTRACTOR shall immediately suspend all or a designated part of the WORKS as may be requested by CLIENT because of dangerous weather or sea conditions or other reasons relating to safety. In this event, CONTRACTOR shall take all reasonable measures to protect the Work Site(s), CLIENT and CONTRACTOR Equipment and their components.

- 18.7 In addition to all legal and specific requirements stated herein, CONTRACTOR and CONTRACTOR's agents, employees, representatives and Sub-contractors who are engaged in the performance of the WORKS shall comply with, abide by and enforce at its sole expense any rules, regulations and standards on safety, drugs, and alcohol, fire protection, and security regulations as set forth by CLIENT in its safety manuals, policies and special instructions.
- 18.8 In addition to all legal and specific requirements stated herein and all Vietnamese legislative requirements, CONTRACTOR and CONTRACTOR'S agents, employees, representatives and Sub-contractors who are engaged in the performance of the WORKS shall comply with, abide by and enforce at its sole expense any rules, regulations, and standards on safety, fire protection, environmental protection and security regulations as set forth by CLIENT in its published safety manuals, policies and special instructions. Before commencing any WORKS, CLIENT requires that CONTRACTOR inspect the Work Site(s) and the equipment involved to ensure that the WORKS will be performed under safe conditions acceptance to CLIENT. These inspections must be evidenced by "Work Permits" issued by CLIENT prior to initiating any such WORKS. CLIENT Representative or his designated representatives shall have the right to prohibit commencement of WORKS or stop any WORKS in progress if the equipment, personnel or WORKS conditions are considered to be unsafe or not to be in compliance with CLIENT rules and regulations.
- 18.9 CONTRACTOR shall prohibit the consumption and/or possession of alcoholic beverages or dangerous drug at the Work Site.
- 18.10 CONTRACTOR shall compile and maintain safety records, data pertaining to its WORKS with CLIENT. These records shall be updated and submitted to CLIENT Representative as and when required.
- 18.11 CONTRACTOR shall be wholly responsible for the safety and safe working practices of its employees, servants or agents, and all equipment, and shall be responsible for the training of its employees, servants or agents on safety and safe working practices. CONTRACTOR shall ensure that the personnel to be provided in the performance of the WORKS are adequately trained in safety precautions and safe working practices before they are involved in the WORKS and that they are competent to undertake their required duties in a safe and efficient manner. CONTRACTOR shall be responsible for maintaining and enhancing manner. CONTRACTOR shall be responsible for maintaining and enhancing the safety awareness among its personnel and Sub-contractor's personnel, including arranging regular safety meetings and emergency drills, Copies of minutes of CONTRACTOR safety meetings shall be submitted to CLIENT.

- 18.12 The employees, servants or agents of the CONTRACTOR when working offshore shall participate in periodic fire and boat drills, instructions in survival, lifesaving and fire fighting.
- 18.13 All personnel assigned to Work Site shall be provided with approved safety helmets, safety glasses, safety shoes and ear protections, by the CONTRACTOR. CONTRACTOR shall also provide to personnel assigned for special jobs with approved life lines, life jackets/life vests, breathing equipment, welding helmets, and all other protective equipment as necessitated by the scope of WORKS and good industrial safety practices.
- 18.14 CONTRACTOR shall allow CLIENT Representative and/or its designated third Party personnel access at any time to conduct audit on the CONTRACTOR Personnel, records and any other matters related to the safety aspect of the WORKS at the Work Site (s).

#### ARTICLE 19 - DEFAULT OF CONTRACTOR

- 19.1 The occurrence of any of the following events shall be deemed a default by CONTRACTOR under this CONTRACT:
- (a) Any attempted transfer or assignment or Sub-contract by CONTRACTOR of its right or duties under this CONTRACT without the prior written consent of CLIENT; or
  - (b) The making by CONTRACTOR of an assignment for the benefits of creditors, the filing by or against CONTRACTOR of a petition in bankruptcy or for corporate reorganisation, or the appointment of a receiver or trustee for CONTRACTOR or the properties of CONTRACTOR; or
  - (c) The failure of CONTRACTOR to satisfy within thirty (30) days of its entry any final judgement upon which execution is possible or the attachment of any general liens against the real or personal property of CONTRACTOR and the continued existence thereof for more than thirty (30) days; or
  - (d) If the CONTRACTOR has in the opinion of CLIENT failed to comply with the CONTRACT or failed to perform the WORKS or part thereof or has failed to adhere to any of its duties and obligations; or
  - (e) The refusal or the inability or other failure of the CONTRACTOR to perform any part of CONTRACT in a safe, efficient, professional, workmanlike, skillful, professional and careful manner in accordance with good industry practices or with the required promptness or diligence; or
  - (f) fulfil its obligations relating to prevention of pollution and substantial pollution result therefrom.
- 19.2 CLIENT shall notify CONTRACTOR in writing of any default and require CONTRACTOR to immediately take appropriate correction action without however prejudicing any of CLIENT rights hereunder or in law or equity.
- 19.3 Notwithstanding the foregoing, in the event of default by CONTRACTOR, CLIENT shall, at CLIENT's sole discretion, enforce the Bank Guarantee for completion of the WORKS.

#### ARTICLE 20 - PROVISION FOR SUSPENSION OF WORKS

- 20.1 CLIENT shall at its option have the right to suspend part or all of the WORKS for any reason whatsoever and shall notify CONTRACTOR of such suspension of WORKS.

During such suspension period, CLIENT shall compensate CONTRACTOR with the mutual agreeable rate.

- 20.2 Neither CLIENT nor CONTRACTOR shall be liable to the other Party for loss of anticipated profits sustained on account of any suspension of the WORKS or part thereof.
- 20.3 CLIENT may, at any time, authorise resumption of all or any part of the suspended WORKS by giving notice to CONTRACTOR specifying the WORKS to be resumed and the effective date of withdrawal of suspension. The WORKS shall be resumed by CONTRACTOR immediately after receipt of such notice, where applicable.

#### ARTICLE 21 - PROVISION FOR TERMINATION OF CONTRACT

- 21.1 CLIENT shall have the right at its option to terminate this CONTRACT or any part thereof pursuant to the following provisions.

21.2 **Termination Without Cause**

- a) CLIENT may at any time, terminate without cause the CONTRACT by giving thirty (30) days prior written notice to CONTRACTOR that CLIENT intends to terminate the CONTRACT, specifying the CONTRACT to be terminated, and the effective date of termination.
- b) Should CLIENT terminate this CONTRACT without cause, CONTRACTOR shall stop performance of all WORKS on the effective date of termination.
- c) Upon receipt and verification of CONTRACTOR's invoice, CLIENT shall pay CONTRACTOR all amounts properly due for the work performed prior to the date of termination and all expenses resulting directly from the termination as approved by CLIENT.

21.3 **Termination For Cause**

- a) Subject to provision provided under **ARTICLE 19 - "DEFAULT OF CONTRACTOR"** hereof, CLIENT shall have the right to terminate for cause the CONTRACT by giving a notice in writing, specifying the CONTRACT to be terminated, and the effective date of termination. In either event, CLIENT shall have available to it all rights and remedies proved in law or equity.
- b) On the date on which the termination for cause given pursuant to provision of **ARTICLE 19 - "DEFAULT OF CONTRACTOR"** becomes effective, CONTRACTOR shall stop performance of the CONTRACT. CLIENT shall, retain all amounts which are then due and payable to CONTRACTOR plus reimbursements due to CONTRACTOR for its reasonable and auditable costs incurred in the performance of the WORKS to the extent such WORKS are authorised in advance by CLIENT.

- 21.4 In addition to CLIENT's rights to terminate as may be provided herein, CLIENT shall be entitled to terminate this Contract under the following provisions :-

- 21.4.1 In the event of Force Majeure continuing for fourteen (14) days as specified in the Article 25 and there is no expectation of improvement of the situation, then CLIENT shall be entitled to terminate this Contract forthwith.

→ A

21.4.2 If at any time during the performance of this Contract, there is any attempted transfer or assignment by CONTRACTOR of its rights or duties under this Contract without the prior written consent of CLIENT.

CLIENT shall be entitled to terminate this Contract on giving notice of termination to CONTRACTOR, such termination shall be effective on the date specified in the notice.

- 21.5 If this CONTRACT or any portion of the WORKS is suspended or terminated and if CLIENT so requests, CONTRACTOR shall immediately make every reasonable effort to cancel existing Sub-contracts, purchase orders or other obligations entered into by CONTRACTOR with Sub-contractors, suppliers or others for the performance of the WORKS, upon terms satisfactory to CLIENT.
- 21.6 CLIENT may direct CONTRACTOR to execute and delivery to CLIENT all documents related to the CONTRACT as required by CLIENT and to take all steps necessary to full vest in CLIENT the rights and benefits of CONTRACTOR under existing Sub-contracts or other obligations with Sub-contractors, suppliers and others. In addition, CONTRACTOR shall do whatever is necessary to preserve and protect the WORKS already in progress, to protect materials, drawings, documents, equipment and supplies in transit or at the Work Site and to minimise all costs to CLIENT and CONTRACTOR resulting from such suspension or termination.
- 21.7 Except as provided above, in the event of termination hereunder, the Parties shall each be released and discharged from any claims by one against the other in connection with the terminated WORKS. Neither CLIENT nor CONTRACTOR shall be liable to the other for loss of anticipated profits sustained on account of such termination.
- 21.8 If in the performance of this CONTRACT, CONTRACTOR causes the CONTRACT to be terminated, or in the event of default by CONTRACTOR, CLIENT shall have the option to thereafter enforce the Bank Guarantee for completion of the WORKS.

#### ARTICLE 22 – SUB-CONTRACTS AND ASSIGNMENT

- 22.1 CONTRACTOR shall not subcontract or assign the WORKS or any part thereof without CLIENT's prior written approval which shall not be unreasonably withheld.
- 22.2 CLIENT shall have the right to disapprove, for reasonable cause, any Subcontractor, supplier, vendor or source of supply selected by CONTRACTOR.
- 22.3 CONTRACTOR shall be fully responsible for any acts, defaults and omissions of any Subcontractors and persons either directly or indirectly employed by Subcontractor to the same extent as it is for the acts and omissions of persons directly or indirectly employed by CONTRACTOR.
- 22.4 CLIENT may assign this Contract including all rights and obligations hereunder at any time with the prior written consent of CONTRACTOR which shall not be unreasonably withheld.
- 22.5 CONTRACTOR shall ensure that all CLIENT's right under this Contract including audit rights are incorporated in all CONTRACTOR's subcontracts hereunder.
- 22.6 Approvals granted pursuant to this **ARTICLE** shall not release or relieve CONTRACTOR of any of its obligations under the CONTRACT or create any contractual relationship between any Sub-contractor and CLIENT.

## ARTICLE 23 - ACCESS AND AUDIT RIGHTS

- 23.1 CONTRACTOR shall maintain and shall cause its Sub-contractors, subsidiaries, and Affiliates to maintain true and correct records of all charges and accounts including gifts and entertainment expenses in connection with the WORKS and all transactions related thereto and shall retain all such records and accounts for a period of not less than thirty-six (36) months after the expiry of the CONTRACT or any extensions or any termination thereof.
- 23.2 From the Effective Date of this CONTRACT and within the time period mentioned above, CLIENT shall have the right, during regular scheduled business hours, to inspect and audit the drawings, plans, instructions, procedures, controls, records, including gifts and entertainment records, and accounts of CONTRACTOR, its Sub-contractors and Affiliates in connection with the performance of this CONTRACT, and are in compliance to the CONTRACT terms and conditions. CLIENT shall have the right to reproduce any such documents, which have been inspected.
- 23.3 CLIENT's claims for omissions, corrections, or errors in charges and credits for CLIENT's account and over-payments of amounts billed by CONTRACTOR and others noted above may be presented at any time during and after the CONTRACT period provided that such claims are made during the course of the CONTRACT and within thirty six (36) months after the expiry of the CONTRACT or any extensions or any termination thereof. CONTRACTOR shall make a written response to CLIENT concerning such claims within thirty (30) days of the date of such claims by CLIENT.
- 23.4 CONTRACTOR shall ensure that the provisions of this **ARTICLE** and **ARTICLE 22 - "SUB-CONTRACTS AND ASSIGNMENT"**, are included in all Sub-contracts it may enter into with its Sub-contractors and Affiliates who will supply any of the labour, equipment, materials, or services to be provided under this CONTRACT.

## ARTICLE 24 - CHANGES

- 24.1 Changes to the WORKS and/or CONTRACTOR Equipment may be required during the performance of WORKS, or any extension of the CONTRACT, and should be handled expeditiously and effectively by the Parties hereto. Such changes may include, but are not limited to additions, deletions, substitutions, alterations, and modifications.
- 24.2 CLIENT shall have the right, at any time, to make any change but such change shall in no way affect the rights or obligations of the Parties hereto except as provided in a written Change Order. All provisions of the CONTRACT shall apply to all changes.
- 24.3 Except as provided in **ARTICLE 24.6** below, CONTRACTOR shall not proceed with any change prior to receipt of a Change Order, unless authorised in writing by CLIENT Contract Administrator.
- 24.4 Should CLIENT desire a change to the WORKS and/or CONTRACTOR Equipment, it shall advise CONTRACTOR of said request. CONTRACTOR shall, upon request from CLIENT Contract Administrator, provide CLIENT within fourteen (14) days a Change Order Proposal defining the terms and conditions of the Change Order Proposal. The terms and conditions shall include, but not be limited to price, method of payment, earliest commencement date, and any other information deemed necessary.
- 24.5 When and if CLIENT approves the Change Proposal, CLIENT will issue to CONTRACTOR a written Change Order in duplicate originals in the form shown in **EXHIBIT V - "CHANGE ORDER PROPOSAL"**. CONTRACTOR shall sign both

A

duplicate originals of the Change Order to indicate its receipt, understanding and acceptance of it. After execution by CLIENT, one duplicate original will be returned to CONTRACTOR.

- 24.6 In cases of extreme urgency for which CONTRACTOR is unable to submit a firm proposal prior to commencement of WORKS on the necessary change, CLIENT may issue a "Preliminary Change Order" to authorise CONTRACTOR to proceed with the change on the basis of an approximate written estimate prepared by CONTRACTOR. As soon as possible thereafter, CONTRACTOR shall submit a Change Order Proposal giving a firm price for the change. If the firm price quoted in the Change Order Proposal is more than that quoted in the "Preliminary Change Order", CONTRACTOR shall furnish CLIENT with the reasons for the differences. Upon agreement of the Parties on the firm price, a Change Order shall be issued as outlined in **ARTICLE 24.5**.

#### ARTICLE 25 - LIQUIDATED DAMAGES

- 25.1 If CONTRACTOR fails to complete the WORKS as specified in the EXHIBIT I – SCOPE OF WORKS thereafter for reasons other than force majeure, then as damages and not as a penalty, to CLIENT for such delay, the CONTRACT PRICE shall be reduced by an amount equivalent to 1% of estimated Contract Price per day to a maximum of 8% of the Contract price.
- 25.2 Further, CONTRACTOR and CLIENT agree that the total amount of liquidated damages payable by CONTRACTOR to CLIENT under these Articles (i.e. Article 26.1) shall not exceed eight percent (8%) of CONTRACT PRICE.
- 25.3 In the event that the CONTRACT PRICE is stated in other than Vietnam Dong, the amount of damages due to CLIENT as provided for under this Article shall be fixed in Vietnam Dong. Such amount shall be converted to the currency in which CONTRACT PRICE is stated, at the rate of exchange prevailing on the day of such payments, in accordance to Article 5 entitled Invoicing and Payment. The amount shall be deducted from payment due or that may become due to CONTRACTOR under the CONTRACT.
- 25.4 CONTRACTOR and CLIENT hereby agree that these amount of liquidated damages are fair and reasonable because of the difficulty of ascertaining the exact amount of damages that CLIENT will sustain by reason of such delay.
- 25.5 CLIENT may, without prejudice to any other method of recovery, deduct the amount of such damages from any payment due to or which may become due to CONTRACTOR. The deduction of such damages shall not relieve CONTRACTOR from its obligations and liabilities under this CONTRACT.
- 25.6 The payment of the liquidated damages is in addition to and not in lieu of or substitution for any other remedy that may be available to CLIENT in the event of delay in completion of the WORKS in accordance with Exhibit II - Schedule of WORKS.

#### ARTICLE 26 - FORCE MAJEURE

- 26.1 Where any Force Majeure event renders impossible or hinders or delays the performance of any obligation (except for the obligation to make payments) or the exercise of any right under this Contract then the failure or omission of CLIENT or CONTRACTOR to perform such obligation shall not be treated as failure or omission to comply with this Contract.

26.2 Upon the occurrence of any Force Majeure event the Party so affected in the discharge of its obligation shall promptly give written notice of such event to the other Party. The affected Party shall make every reasonable effort to remove or remedy the cause of such Force Majeure or mitigate its effect as quickly as may be possible. If such occurrence results in the suspension of all or part of the Works for a continuous period more than fourteen (14) days, the Parties shall meet and determine the appropriate measures to be taken. In the event the Parties do not agree, CLIENT have the right to terminate the forthwith in which case neither Party shall have any further obligation or liability hereunder.

26.3 The events falling within Force Majeure include acts of God or force of nature, landslide, lightning, earthquake, flood, fire, explosion, storm or storm warning, tidal wave, shipwreck and perils to navigation (other than adverse sea or weather conditions), act of war (declared or undeclared) or public enemy, strike (excluding strikes, lockouts or other industrial disputes or action amongst employees of CONTRACTOR or its Subcontractors) act or omission of sovereign states or those purporting to represent sovereign states, blockade, embargo, quarantine, public disorder, sabotage, accident or similar events beyond the control of the Parties or either of them.

However, the following occurrences shall not be considered as Force Majeure:

(a) Late delivery of CONTRACTOR's Equipment caused by an oversold condition of the market, inefficiencies, lack of funds or similar occurrences; or

(b) Late performance by CONTRACTOR and/or a Subcontractor caused by unavailability of equipment, supervisors or labour, inefficiencies, lack of funds or similar occurrences; or

(c) Mechanical breakdown of any item of CONTRACTOR or its Subcontractors equipment, plant or machinery; or

(d) Delays due to ordinary storm or inclement weather; or

(e) Non-performance by Subcontractors

unless the delay arises out of a Force Majeure occurrence and is beyond both CONTRACTOR's and the Subcontractor's control and an alternate acceptable source of services, equipment, or material is unavailable. Additionally, Force Majeure shall not include financial distress of CONTRACTOR or any Subcontractor.

26.4 Any delay or failure in performance by either Party hereto shall not give rise to any claims for damages or loss of anticipated profits if, and to the extent, such delay or failure is caused by Force Majeure.

#### ARTICLE 27 - CONFLICT OF INTEREST

27.1 CONTRACTOR shall exercise care and diligence to prevent any actions being taken or conditions from arising, which could result in a conflict with CLIENT's best interest. This obligation shall apply to the activities of the employees and agents of CONTRACTOR in their relations with CLIENT's employees and their families, and with suppliers, Subcontractors, and third parties, arising from the CONTRACT or related to the performance of the WORKS.

27.2 CONTRACTOR's efforts shall include, but not be limited to, establishing precautions to prevent its employees, officers or agents from making, receiving, providing, or offering

gifts, entertainment, payments, loans, or other considerations for the purpose of influencing individuals to commit acts contrary to CLIENT's best interest.

#### ARTICLE 28 - WAIVERS

- 28.1 The failure of CLIENT, at any time, or from time to time to enforce, or to require the strict adherence and performance of any of the terms and conditions of the CONTRACT, to exercise any option, right, or privilege hereunder, or to demand compliance as to any obligation or covenant, shall not constitute a waiver of any such terms and conditions and/or affect or impair such terms or conditions in any way, or the right, privilege, or option of CLIENT, or of the strict performance of CONTRACTOR thereof unless an express waiver is properly executed and evidenced in writing.
- 28.2 Waivers by CLIENT of any breach or non-observance by CONTRACTOR of any of the terms and conditions of this CONTRACT shall not constitute or be construed as a waiver of any succeeding breach or non-observance of the same or any other terms or conditions.

#### ARTICLE 29 - CONFIDENTIALITY

- 29.1 CONTRACTOR shall obtain written approval from CLIENT prior to making any publicity release, public statements or announcement regarding the CONTRACT and the performance of the WORKS or CONTRACTOR's activities related to its participation in the WORKS.
- 29.2 CONTRACTOR shall at all times hold confidential and shall not, without CLIENT's prior written approval, divulge to third parties or use in any way other than for accomplishing the WORKS or for purposes other than that specified in the CONTRACT, any technical information or any processes, process data or calculations or any drawings or designs showing the equipment, devices and machinery by which the processing is to be performed or carried out, disclosed, directly or indirectly, to CONTRACTOR by CLIENT or its Affiliates in regard to the WORKS or the results thereof.
- 29.3 Upon completion of the WORKS or upon receipt by CONTRACTOR of CLIENT's notification of termination of the WORKS or any part thereof as the case may be, CONTRACTOR shall return to CLIENT all documents, drawings, and data provided to CONTRACTOR by CLIENT.
- 29.4 CONTRACTOR shall ensure that the provisions of this **ARTICLE** are adhered to by its employees, its Sub-contractors, and Sub-contractor's employees and shall promptly notify CLIENT upon discovery of any instance where the requirements of this **ARTICLE** have not been complied with.
- 29.5 This **ARTICLE** shall continue in force notwithstanding the completion or earlier termination of this CONTRACT.
- 29.6 The provisions of this **ARTICLE** shall not apply:
- (a) insofar as any of the documents, drawings, and data referred to in the WORKS are part of public knowledge or literature at the date of their receipt by the CONTRACTOR as from such date;
  - (b) insofar as any of the documents, drawings, and data referred to in the WORKS become part of public knowledge or literature after the date of their receipt by the CONTRACTOR as from such subsequent date;

- (c) insofar as any of the documents, drawings, and data are developed by the CONTRACTOR independently of the CONTRACT.
- (d) insofar as any of the documents, drawings, and data lawfully becomes known or available to the CONTRACTOR from third party who are not under a similar agreement, directly or indirectly, with CLIENT hereto.
- (e) where disclosure is required to be made in order to comply with the requirements of any law, rule or regulation of any governmental or regulatory body having jurisdiction over the WORKS or the CONTRACTOR , or of any relevant stock exchange.



### ARTICLE 30 - ARBITRATION

- 30.1 Any dispute between the Parties as to the performance of this CONTRACT or the rights or liabilities of the Parties herein, or any matter arising out of the same or connected therewith, which cannot be settled amicably shall be settled by The Vietnam International Arbitration Centre at the Vietnam Chamber of Commerce and Industry (VIAC) in accordance with its Rules of Arbitration, before a board of three (3) arbitrators. Each of the Parties hereto shall be entitled to appoint one arbitrator and the two arbitrators shall agree on a third arbitrator. In the event agreement upon the third arbitrator cannot be reached, the third arbitrator shall be appointed by the VIAC's President. It is agreed, however, that no one who is an employee of either Party or who is in anyway financially interested in this CONTRACT shall be appointed to act as an arbitrator.
- 30.2 Such arbitration shall be held at Ho Chi Minh City, Socialist Republic of Vietnam. The award of the arbitrators shall be final and binding upon the Parties. The costs of the arbitration shall be borne by the Party whose contention was not upheld by the arbitration tribunals, unless otherwise provided in the arbitration award. The language of the Arbitration shall be in English language.
- 30.3 Notwithstanding the foregoing, the Parties may agree that any particular matter of disputes can most expeditiously be settled by an Expert. In that event, the Parties shall jointly prepare and sign a statement on the issue to be determined by the Expert before agreeing upon the identity of the Expert. The Parties shall then agree upon the identity of the Expert to determine the issue described in the said statement and the decision of the Expert on that issue shall be final and binding on the Parties without further arbitration on that issue. If the Parties cannot agree upon the identity of the Expert within fourteen (14) days after the date the last Party signs the aforesaid statement of the issue, then the dispute shall be referred to arbitration as indicated above.

### ARTICLE 31 - COMPLIANCE WITH LAW

- 31.1 CONTRACTOR and its Sub-contractors shall be subject to all applicable laws in connection with the WORKS. If CONTRACTOR or its Sub-contractors perform any part of the WORKS in breach of the law, then CONTRACTOR shall bear any additional costs of the WORKS resulting from said violation and correction thereof. For the purpose of this **ARTICLE**, "law" includes any laws (national, state, municipal, local, or others) and any requirements, ordinances, rules, or regulations of any relevant authority or agency (national, state, municipal, local, or other).
- 31.2 CONTRACTOR shall not enter into negotiations with any relevant authority or agency to develop acceptance to exemption, composition, variation, or revision to law in connection with this CONTRACT without CLIENT's prior written approval.
- 31.3 CONTRACTOR shall be responsible for and shall bear all the costs of obtaining all necessary licences, permits, and authorisations required by law that must be obtained in CONTRACTOR'S name from the relevant governmental authorities for CONTRACTOR to do business in the country, or countries wherein any part of the WORKS is performed, and shall give all required notices.
- 31.4 CONTRACTOR shall, at CONTRACTOR's cost, defend, indemnify, and hold CLIENT and its Affiliates harmless from all forms of penalty which may be imposed on CLIENT and its Affiliates by reason of any alleged or violation of law by CONTRACTOR or its Sub-contractors and also from all claims, suits, or proceedings that may be brought against CLIENT and/or its Affiliates arising under, growing out of, or by reason of the WORKS

with respect to such alleged or violation of law whether brought by employees of CONTRACTOR or its Sub-contractors or by third parties or by any relevant authority.

- 31.5 CONTRACTOR's obligations under this **ARTICLE** shall include, without limitation, obtaining all necessary or appropriate import and export licences and Customs clearances for materials, tools, parts and spares, and equipment for the WORKS and providing all documentation in support of such licenses and clearance.

#### ARTICLE 32 - GOVERNING LAW AND LANGUAGE

- 32.1 The validity and interpretation of this CONTRACT and the legal relations of the Parties to it shall be governed by the substantive laws of Vietnam, without having regards to its conflicts of law's provisions.
- 32.2 All documents produced by CONTRACTOR in the performance of this CONTRACT as well as all written communications between CLIENT and CONTRACTOR shall be written in the English language which is hereby designated the governing language of the CONTRACT. CONTRACTOR and CLIENT may use any language within their own organisations, except that all Sub-contracts and all written communications pertaining to them shall be in English.

#### ARTICLE 33 - PATENTS AND OTHER PROPRIETARY RIGHTS

##### 33.1 COPYRIGHT

CONTRACTOR shall promptly give notice to CLIENT if CONTRACTOR has or acquires knowledge or any copyright under which a suit for infringement could reasonably be brought because of the use by CLIENT of any designs, processes, methods or Works product information incorporated or to be incorporated by CONTRACTOR in the performance of Works. Following notification to CLIENT, CONTRACTOR shall not incorporate into the Works these designs, processes, methods or Works product information without CLIENT's prior written approval.

Where designs, processes, methods and Works product information specified and used by CONTRACTOR in the accomplishment of Works infringe any copyright, CONTRACTOR shall indemnify, defend and hold CLIENT and their Affiliates harmless from and against any and all claims, demands or causes of action of whatever nature and shall further agree to pay all costs, including counsel and witness fees, court costs, awards, damages and any and all expenses incurred by or assessed against CLIENT resulting from such claims, demands or causes of action.

In case the said designs, processes, methods and Works product information or any part thereof is held by such a suit to constitute infringement and its use enjoined, CONTRACTOR shall at its own expense either procure for CLIENT the right to continue using the designs, processes, methods and Works product information or replace the designs, processes, methods and Works product information with non-infringing designs, processes, methods and Works product information or modify the designs, processes, methods and Works product information so as to remove the infringement. Where, however, an infringement of any copyright occurs as to design, process, method and Works product information expressly specified by CLIENT, CLIENT shall indemnify and save CONTRACTOR harmless from any loss on account of claims for copyrights infringement against CONTRACTOR provided that CONTRACTOR notifies CLIENT immediately upon receiving notice of infringement.

##### 33.2 PATENTS

In the event CONTRACTOR files a patent application in which any of the technical information provided to CONTRACTOR by CLIENT or by any subsidiary or Affiliate is disclosed, CONTRACTOR agrees to provide CLIENT with a copy of such application. If such application includes technical information of CLIENT or its Affiliates which is proprietary, CONTRACTOR shall not permit the publication in any country of a patent based on such application without CLIENT's prior written approval.

### 33.3 TECHNICAL INFORMATION

Title to all drawings, specifications, requisitions, calculations, and other patent documents. Design concepts, technical information prepared by CONTRACTOR or its Subcontractors solely for the Contract or any invention development by CLIENT from information received shall be vested in CLIENT and may be used by or for CLIENT, for any purposes.

### ARTICLE 34 - ENTIRE AGREEMENT

This CONTRACT constitutes the entire agreement between the Parties hereto and supersedes all prior negotiations, representations or agreements related to this CONTRACT, either written or oral, including CLIENT's bid document and CONTRACTOR's proposal(s) except to the extent they are expressly incorporated into this CONTRACT. No changes, alterations, or modifications to this CONTRACT shall be effective unless in writing, and executed by the authorised signatories of CLIENT and CONTRACTOR.

### ARTICLE 35 - NON-EXCLUSIVE AGREEMENT

This CONTRACT is non-exclusive and CLIENT reserves the right, without having to give any reason whatsoever to engage other suppliers and/or contractors to supply and/or perform similar or identical WORKS. CONTRACTOR shall afford such other contractors adequate opportunity to carry out their contracts and shall accomplish the WORKS in co-operation with those contractors and with CLIENT.

### ARTICLE 36 - INDEPENDENT CONTRACTOR

- 36.1 CONTRACTOR is an independent contractor and neither CONTRACTOR nor its employees, nor CONTRACTOR's Sub-contractors or their employees, are agents or employees of CLIENT. The entire performance, operation, management, and control of CONTRACTOR Equipment shall be under the exclusive control and command of CONTRACTOR. CONTRACTOR's primary purpose shall be to perform all acts necessary to execute the WORKS consistent with safety and good oilfield practice.
- 365.2 It shall be the sole exclusive duty of CONTRACTOR to determine at all times whether the WORKS can be safely continued or undertaken. It shall be CONTRACTOR's duty to inspect and ensure that all cargo and items of equipment located at the Work Site(s) and at CONTRACTOR's onshore base are stored in a proper and safe manner and in all respects fit and suitable to undertake any contemplated operation under the then existing conditions.
- 36.3 The presence of, and the inspection and supervision by, CLIENT Representative(s) at the Work Site(s) shall not relieve CONTRACTOR from CONTRACTOR's obligations and responsibilities.

ARTICLE 37 - SURVIVAL OF OBLIGATIONS

Notwithstanding anything to the contrary written in this CONTRACT, the liabilities, indemnity and obligations of CLIENT and CONTRACTOR under this CONTRACT arising prior to the termination or completion of this CONTRACT shall survive any termination, repudiation, cancellations or completion of this CONTRACT.

ARTICLE 38 - LIMITATION OF LIABILITY

Neither Party shall be responsible to the other for any indirect or remote losses of any kind including but not limited to loss of revenue or anticipated profits, loss of production, loss of business opportunity or business interruption, regardless of cause and even if caused by negligence or breach of contract resulting from the carrying out of the operations or the exercise of rights by the Parties under this CONTRACT.

ARTICLE 39 - NOTICES

- 39.1 All notices required herein shall be in writing and made to either Party and shall be deemed to have been properly given or made to the Party it is addressed to if the notices are sent to the respective Party at the address as indicated below:-

CLIENT:

**DOMESTIC PETROLEUM OPERATING BRANCH - PETROVIETNAM  
EXPLORATION PRODUCTION CORPORATION LIMITED**

15<sup>th</sup> Floor Victory Tower, 12 Tan Trao Street  
Ho Chi Minh City, S.R Vietnam

ATTN : <<To be confirmed >>  
CC. : <<To be confirmed >>

CONTRACTOR:

NAME : To be specified by CONTRACTOR  
ADDRESS : “  
TELEFAX : “  
TELEPHONE : “  
ATTENTION :

- 39.2 The date of any notice shall be either the date it is first delivered received at the office of the addresser, or the date it is first received by the addressee, whichever is earlier.

Written notice or instruction shall be deemed to have been received :

If delivered by hand - At time of delivery to either Party  
If sent by fax - At time of transmission  
If sent by registered mail - At time of receipt or recorded delivery.

- 39.3 If the time of such deemed receipt of notice is not during customary hours of business, notice shall be deemed to have been received at 10:00 A.M. on the first customary day of business thereafter.
- 39.4 Either Party may change the person or address to which notice shall be sent by giving the other Party written notice of such change.

**SIGNATORIES**

This Contract shall inure to the benefit of and be binding upon the legal representatives, successors and assigns of the Parties hereto.

**IN WITNESS WHEREOF**, the Parties have caused this CONTRACT to be executed in duplicate originals in their respective corporate names by their respective officers, thereunder duly authorised, as of the date and year first above written.

**CLIENT**

**CONTRACTOR**

**For and on behalf of  
DOMESTIC PETROLEUM  
OPERATING BRANCH -  
PETROVIETNAM EXPLORATION  
PRODUCTION CORPORATION  
LIMITED**

**For and on behalf of  
(CONTRACTOR'S Name)**

\_\_\_\_\_  
Name :

\_\_\_\_\_  
Name :

Designation :

Designation :

## EXHIBIT I

### SCOPE OF WORKS

#### **I. Introduction:**

##### **1.1. Objectives:**

The Dai Hung 01 Floating Production Unit (FPU – DH01) is a critical offshore facility located in the Dai Hung oil field, Vietnam. Long-term operation and exposure to cyclic environmental loads have led to fatigue degradation in several structural components, particularly diagonal brace-to-column connection joints.

This proposal presents a comprehensive plan to retrofit and strengthen these critical joints, with the following key objectives:

- Enhance stiffness and load-carrying efficiency;
- Reduce stress concentration and improve fatigue resistance;
- Ensure damage tolerance and safe operation in the presence of localized cracks;
- Extend structural service life and maintain compliance with offshore integrity standards.

The Contractor proposes a systematic engineering approach, combining advanced survey, structural analysis, fatigue assessment, fracture mechanics, and risk-based planning to deliver a safe, reliable, and cost-effective retrofit solution.

##### **1.2. FPU DH-01 description:**

Dai Hung 01 FPU and CALM operation in Dai Hung field. The Dai Hung field is located in Block 05.1A, approximately 250 km, from the coastline of the South Eastern Vietnam, and situated in a water depth of 110 m (average). The field is operated by PVEP POC.

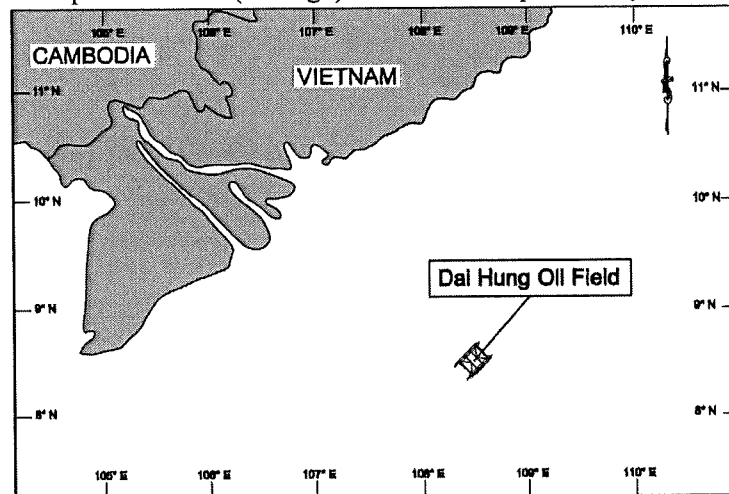

*Figure 1 Location layout of Dai Hung Field, Vietnam*

The Dai Hung 01 is a semi-submersible vessel of the Aker H3.2 design, with two lower pontoons carrying the deck on 4 columns per pontoon. One additional buoyancy column is fitted at the aft side of each of the two pontoons. Dai Hung 01 FPU had modified to suit the requirements of the Dai Hung field.

Main particulars pontoon length : 108.2 m  
Breadth moulded : 67.36 meters

A

Main deck length	:	68.6 meters
Main deck elevation	:	36.6 meters
Main deck breadth	:	60.92 meters
Maximum draught	:	21.3 meters
Lightship weight	:	10715 t
Displacement	:	20543 t
Draft - Operational	:	21.34 m
Draft - Survival	:	19.51 m
Draft - Transit	:	6.7 m

The vertical distance from the edge of the pontoon to seawater level (freeboard) has been set to 1 ft. The vertical distance from the vessel baseline to riser balcony is 7.7 m.

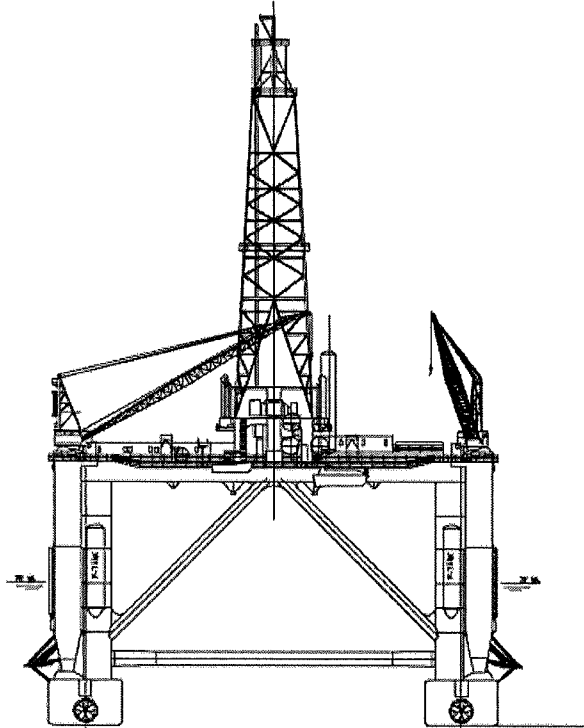

*Figure 2: Dai Hung 01 stern view*

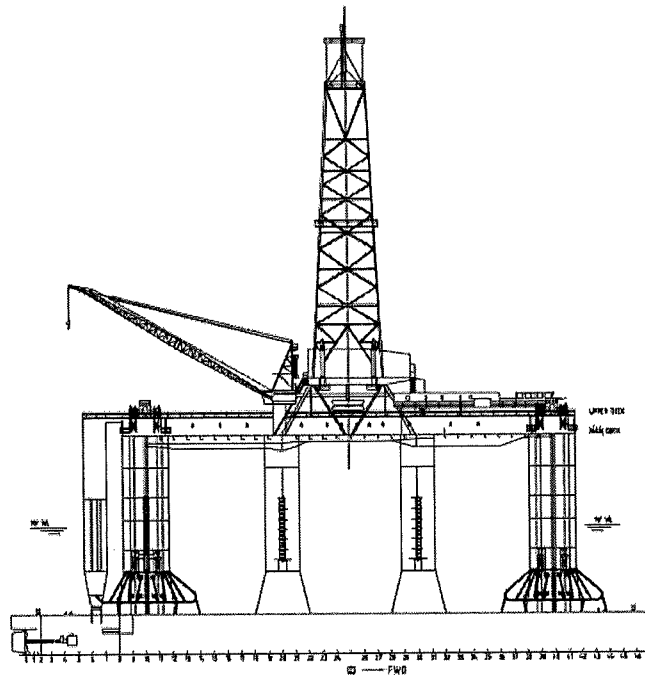

Figure 3: Dai Hung 01 starboard view

Mooring systems : Eight (8) mooring chains (98 mm diameter NVK4 RIG, studded) anchor the FPU to the seabed via 37 t Stevshark high holding power marine drag anchors. The minimum design breaking strength (MBS) of the mooring chains are 10600 kN. The length of each of the mooring line is 1150 m including the chain contained in the chain lockers. One 100 m chain section (in the chain lockers) is connected to each of the main mooring chain segments by a 98 mm kenter-link. The eight mooring lines are run by four 300 HP double wildcat winches. The mooring lines are pre-tensioned to 70 t at operational draft (21.34 m)

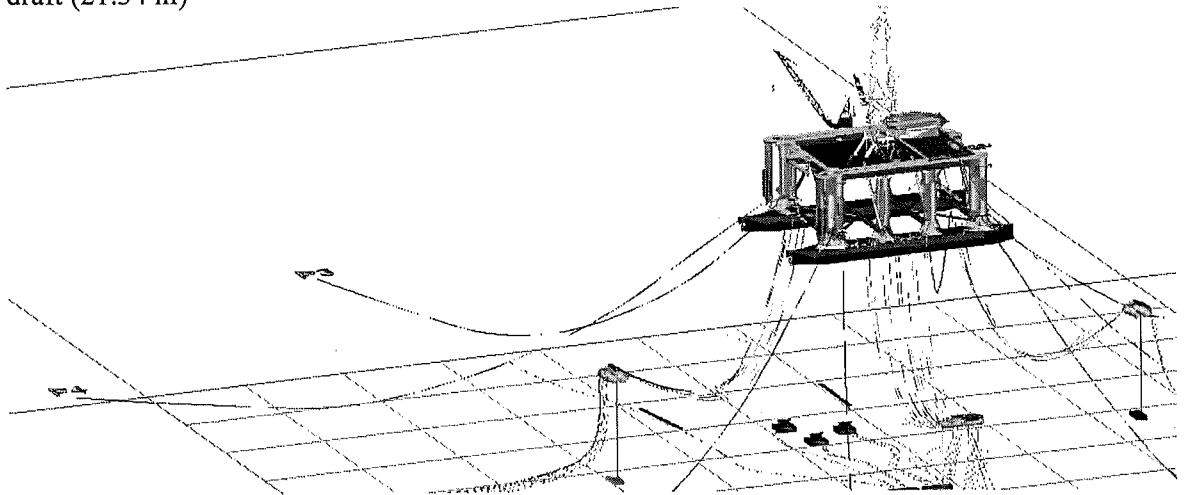

Figure 4: 3D general layout of Mooring System of Dai hung 01

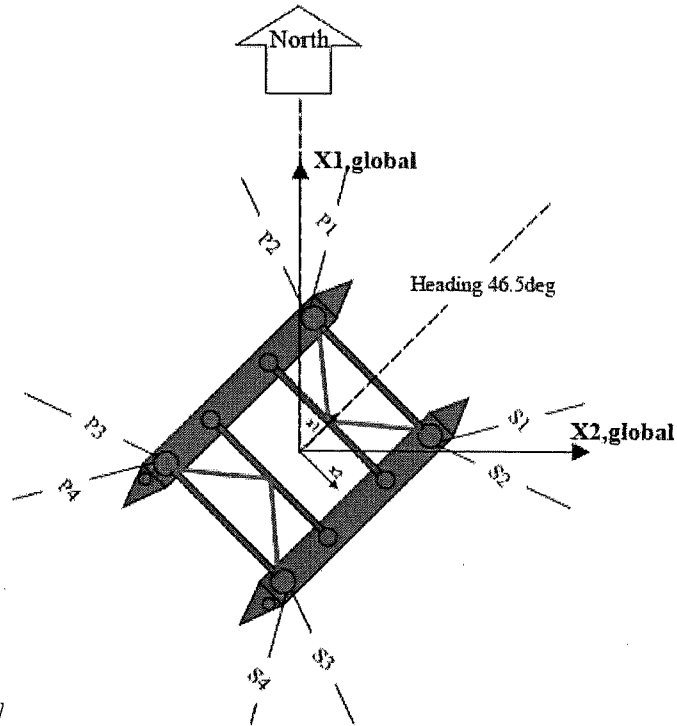
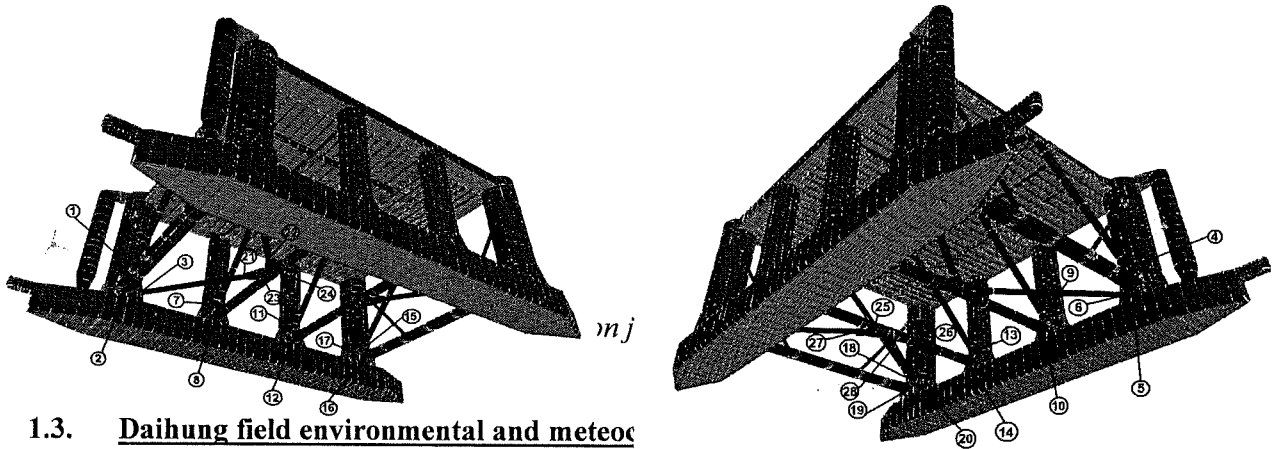

Figure 5: Layout of position & Mooring System of Dai hung 01 FPU



**1.3. Daihung field environmental and meteo**

Location : Block 05/1a (Dai Hung Field)  
 Water depth : 108 m  
 Distance from Vung Tau base : 260 km  
 Air temperature: in range of 21.5oC to 38oC

**Wind:**

Wind speed in average period of 2 minute (North-East) 49.3 m/sec  
 Wind speed in average period of 10 minute (North-East) 45.8 m/sec

**Wave:**

Average height : 5.3 m  
 Average period : 8.7 sec  
 Average length : 162 m  
 Wave height 0.1% : 15.1 m  
 Wave height 10% : 12.7 m  
 Wave height 13% : 8.3 m

Wave crest : 10.1 m  
**Current:**  
On surface:  
Current speed: 215 cm/sec  
Current direction: 85o  
At bottom:  
Current speed: 130 cm/sec  
Current direction: 60o  
Tide (v/s average record in several years)  
Highest: 1.9 m  
Lowest: 2.3 m

## **II. Scope of Work**

### **2.1. Background and Rationale**

- The brace-to-column connection joints have exceeded their original fatigue design life.
- Stress concentration phenomena at these joints may lead to cracking and reduction in load-bearing capacity.
- Retrofit is required to ensure the unit remains safe under critical operating conditions and can temporarily withstand localized damage until repair or replacement is performed.

### **2.2. Detailed Scope of Work**

#### a) Survey and Condition Assessment

- Collect field data, original design drawings, and previous inspection records.
- Process measurement results and perform non-destructive testing (NDT) at critical joints.
- Assess mechanical degradation and fatigue crack risk.

#### b) Retrofit Engineering Design

- Propose new joint configurations with higher stiffness.
- Optimize geometry to reduce stress concentration.
- Integrate materials with higher crack-arrest capability and toughness.
- Ensure the design provides temporary load-carrying capacity even in the presence of cracks.

#### c) Global Structural Strength Analysis

- RAO motion analysis
- Perform overall structural integrity assessment under operational and extreme load conditions.

#### d) Stochastic Fatigue Analysis

- Apply wave/wind spectra to generate random time-varying loads.

Contract No.....

— A

- Conduct dynamic response analysis of the unit using spectral methods or time-domain simulations.
  - Hotspot stress identification:
    - Extract stresses at critical locations from FEA models.
    - Apply SCF corrections based on geometry and weld details.
  - Fatigue life estimation:
    - Convert load cycles using Rainflow counting.
    - Accumulate damage using Palmgren–Miner rule.
    - Compare with S–N curves to determine remaining fatigue life.
  - Reliability assessment:
  - Perform probabilistic fatigue analysis.
  - Determine fatigue safety factors in accordance with standards.
- e) Fracture and Crack Propagation Analysis
- Crack scenarios: Surface/root weld cracks, corner cracks at brace–column intersections; initial crack size based on NDT results.
  - Toughness evaluation: Calculate  $K/J$  values, compare with  $K_{IC}/J_{IC}$ ; assess flaw tolerance and load capacity in cracked condition.
  - Fatigue crack growth: Apply Paris law/FCGR under offshore environment; predict crack growth rate and time to critical size; define safe inspection intervals.
  - Damage tolerance: Establish allowable operating loads in the presence of cracks; recommend safety factors and temporary operating limits.
- f) Risk Analysis and Inspection Plan
- Develop a risk matrix for potential joint failure scenarios.
  - Propose post-retrofit inspection procedures (NDT, vibration monitoring, residual stress checks).
  - Define alarm thresholds and emergency actions upon crack detection.

### III. Progress

Phase	Key Activities	Duration
1	Mobilization & Planning	1 weeks
2	Survey & Condition Assessment	4 weeks
3	Engineering Design &	8 weeks

Phase	Key Activities	Duration
	Analysis	
4	Design Verification & Approval	3 weeks
<b>Total : 16 weeks</b>		

#### IV. Methodology & Execution Plan

##### 4.1. Project Execution Strategy

- Phased Approach:
  1. Preparation & Mobilization
  2. Survey & Condition Assessment
  3. Engineering Design & Analysis
  4. Design Verification & Approval
  5. Post-Retrofit Planning & Reporting
- Integrated Engineering Workflow:
  - Survey and inspection data feed directly into design and analysis.
  - Iterative optimization to ensure compliance with fatigue, fracture, and load requirements.
- Risk-Based Prioritization:
  - Critical joints prioritized according to stress, fatigue history, and operational importance.

##### 4.2 Survey & Inspection

- Advanced NDT: ultrasonic, dye-penetrant, radiography.
- In-situ measurement of deformation and strain where feasible.
- Structured digital data collection for analysis integration.

##### 4.3 Engineering Design & Analysis

- Evaluate multiple retrofit solutions.
- Finite element analysis (FEA) for global and local responses.
- Stochastic fatigue, fracture mechanics, and damage tolerance assessment.

Design verification against load-carrying, stiffness, and fatigue life criteria.

##### 4.4 Quality Assurance

A

- QA/QC system in compliance with ISO 9001 and offshore integrity management standards.
- Peer review of calculations and FEA models.
- Traceability matrix linking inspection data, analysis, and design decisions.

#### 4.5 Safety & Environmental Management

- All activities under Contractor's HSE Management System.
- Job Safety Analysis (JSA) prior to fieldwork.
- Compliance with offshore permit-to-work, lifting, and confined space procedures.

#### 4.6 Reporting & Deliverables

- Weekly progress reports.
- Interim design and analysis reports.
- Final engineering package: calculations, FEA, fatigue & fracture assessment, risk & inspection plan, operational recommendations.

### **V. Deliverables**

1. Condition assessment and inspection report
2. Retrofit design basis and detailed calculations
3. Global structural analysis and fatigue assessment report
4. Fracture mechanics, crack growth, and damage tolerance evaluation
5. Risk assessment and inspection planning documentation
6. Final comprehensive report confirming compliance with offshore standards

### **VI. Risk Management & Safety**

1. Risk-based prioritization of retrofit work.
2. Mitigation measures for operational, environmental, and technical risks.
3. Emergency procedures and alarm thresholds for crack detection.
4. Full compliance with HSE standards and offshore safety regulations.

### **V. Responsibility of PVEP-POC**

1. Provide the full specifications of Semi- Submersible Dai Hung -01
2. Supporting bidder's personnel in travelling from Vung Tau airport to DH 01 semi-submersible when exchanging shift. (It may be necessary for FPU DH-01 to conduct an on-site survey, or it may not be required)
3. Delegating supervisor to check the work of contractor.
4. Co-operating with sub-contractor in checking and making acceptance record after completing repaired service.

**EXHIBIT II**

**EQUIPMENT, MATERIALS, SUPPLIES AND SERVICES**  
**TO BE PROVIDED BY CONTRACTOR**

CONTRACTOR to propose for CLIENT's approval

— A



**EXHIBIT III**

**CONTRACT PRICE**

THE FOLLOWING PRICES ARE INCLUSIVE OF ALL COSTS TO COMPLY WITH THE CONTRACT FORM, SCOPE OF WORKS, HSE REQUIREMENT, SPECIFICATIONS AND OTHER APPLICABLE PROCEDURES.

Pursuant to **ARTICLE 4**, **ARTICLE 7** and **ARTICLE 9**, CLIENT shall compensate CONTRACTOR in accordance with the rates specified herein which are exclusive of applicable Vietnamese taxes (withholding taxes/ VAT), which, if applicable, shall be borne by CLIENT, except for the Contractor's personnel income tax.

**NOTE:** The proposed CONTRACT PRICE shall indicate whether it is inclusive of Vietnamese taxes (VAT, CIT, ect) or not. In the event that the quoted prices do not specify this, they shall be treated as inclusive of all taxes.

Pursuant to **THE CONTRACT**, CLIENT shall compensate CONTRACTOR in accordance with the rates specified herein:

No.	Description	Unit	Q'ty	Unit Price (VND)	Total Price (VND)
1	Provision services of Retrofit of Diagonal Brace-to-Column Connection Joints of Dai Hung 01 FPU	Lot	1		
<b>Total Amount (exclusive of VAT)</b>					
<b>VAT</b>					
<b>Total Amount (inclusive of VAT)</b>					

(\* ) *The proposed CONTRACT PRICE shall indicate whether it is inclusive of Vietnamese taxes (VAT, CIT, etc.) or not. In the event that the quoted prices do not specify this, they shall be treated as inclusive of all taxes.*

**TABLE 2: BREAKDOWN PRICE (if any)**

*Unit: USD/VND*

CONTRACTOR is requested to provide the detailed breakdown for the lump sum CONTRACT PRICE.

Item	Description	Unit	Qty.	Price (VND)	Total Price (VND)
1	Collection of relevant data and information/documents	Lot	1		
2	Survey and Condition Assessment	Lot	1		
3	Retrofit Engineering Design	Lot	1		
4	Inplace analysis:	Lot	1		

A

Item	Description	Unit	Qty.	Price (VND)	Total Price (VND)
	Global Structural Strength				
	Stochastic Fatigue				
	Fracture and Crack Propagation				
5	Risk Analysis and Inspection plan	Lot	1		
6	VR's approval document(s) for final reports	Lot	1		
	<b>Total Amount</b>				

**MILESTONE PAYMENT SCHEDULE**

Milestone No.	Description	Documentation/ Acceptance Criteria	Payment Amount (%)
1.	Completion of WORKS	1) Payment request; 2) Signed commercial Invoice; 3) Daily report (Original); 4) Certificates as stipulated in Exhibit I; 5) Acceptance protocol approved by CLIENT.	100% of Lump sum CONTRACT PRICE

Note: Contractor shall comply with instructions and guidelines when repairing and submitting invoice in accordance with EXHIBIT VI - INVOICE PROCEDURES AND ADMINISTRATION GUIDELINES herein

**EXHIBIT IV**  
**FORM OF BANK GUARANTEE**

*Letterhead of Bank*

**BANK GUARANTEE**

TO CONTRACT No. [...] DATED .....

**TO : PVEP-POC**

**ADD:**

Dear Sir,  
[.....]

Issuing

date:

Re: Our **BANK GUARANTEE** No.[...] for VND [.....]

We have been informed that you (hereinafter called CLIENT) have concluded a Contract No. \_\_\_\_\_ (hereinafter called CONTRACT) with (insert the name of the company) (hereinafter called CONTRACTOR) for the ..... and according to the CONTRACT, CONTRACTOR is required to provide you with a BANK GUARANTEE by a first class Bank in the amount up to VND \_\_\_\_\_ (Vietnam Dong) which is ten percent (10%) of the total CONTRACT PRICE.

In consideration of the above, we (name of the Bank), waiving all rights of objection and defense arising from the principal debt, hereby irrevocably and unconditionally undertake to pay immediately to you upon your first written demand stating that CONTRACTOR has failed to fulfill wholly or partly its contractual obligations under the said CONTRACT, any amount or amounts as specified by you up to a total of VND \_\_\_\_\_ (Vietnam Dong) without the requirement for you to prove or to show grounds or reasons for your demand or the amount specified.

The payment under this BANK GUARANTEE shall be made by us without any deductions for fees and free of any taxes, imports, levies or duties present or future of any nature within \_\_\_\_\_ (*name of the country*).

This BANK GUARANTEE is effective from its issuing date first above written, and valid up to the expiration of the WARRANTY period as stipulated in Article heads as WARRANTY of the CONTRACT plus thirty (30) days.

This BANK GUARANTEE is subject to the Uniform Rules for Demand Guarantee of the International Chamber of Commerce (*Publication No. 458*) and shall be governed by and construed in accordance with the Laws of S.R.Vietnam.

(Name of Bank)

By: \_\_\_\_\_

Title: \_\_\_\_\_

(Authorized signature with stamp of Bank)

A



**EXHIBIT V**

**CHANGE ORDER**

Changes to the WORKS and/or CONTRACTOR's Equipment except for CONTRACTOR's Personnel as specified herein, may be required during the performance of WORKS any extension of the Contract and should be handled expeditiously and effectively by the Parties hereto. Such changes may include but not be limited to additions, deletions, substitutions, alterations and modifications.

CLIENT shall have the right, at any time, to make any change but such change shall in no way affect the rights or obligations of the parties hereto except as provided in a written Change Order. Changes shall be carried out in accordance with the provisions of the Contract.

Except as provided below, CONTRACTOR shall not proceed with any change prior to receipt of a Change Order, unless authorized in writing by the CLIENT's Contract Administrator.

The procedure for handling and issuing Change Orders shall be as follows:-

- V-1 Should CLIENT desire any change to the CONTRACT Equipment, it shall advise CONTRACTOR of said request. CONTRACTOR shall, upon request from CLIENT, provide CLIENT within fourteen (14) days a CHANGE PROPOSAL in the form shown in **APPENDIX V-1** defining the terms and conditions of the CHANGE PROPOSAL. The terms and conditions shall include but not be limited to price, method of payment, earliest commencement date and any other information deemed necessary.
- V-2 When and if CLIENT approves the Change Proposal, CLIENT will issue to CONTRACTOR a written Change Order in duplicate originals as per **APPENDIX V-2**. All Change Order shall be numbered sequentially.
- V-3 CONTRACTOR shall sign and promptly return to CLIENT both duplicate originals of the Change Order to indicate its receipt, understanding and acceptance of it. After CLIENT execution, one duplicate original will be returned to CONTRACTOR.
- V-4 In cases of extreme urgency for which CONTRACTOR is unable to submit a firm proposal prior to commencement of work on the necessary change, CLIENT may issue a "Preliminary Change Order" to authorize CONTRACTOR to proceed with the change on the basis of an approximate written estimate prepared by CONTRACTOR. As soon as possible thereafter, CONTRACTOR shall submit a Change Proposal giving its firm price for the change. If the firm price quoted in the Change Proposal is more than that quoted in the "Preliminary Change Order", CONTRACTOR shall furnish CLIENT with

the reasons for the differences. Upon agreement of the Parties on the firm price, a Change Order shall be issued as outlined in **EXHIBIT V**.



**APPENDIX V-2  
CHANGE ORDER FORM**

**CHANGE ORDER**

CO No....

CONTRACT TITLE : _____ CONTRACT No. : _____ CONTRACTOR : _____ WORK LOCATION : _____ DEPARTMENT : _____	DATE : _____								
DESCRIPTION OF WORK/CHANGE :  REASONS FOR CHANGE :									
EFFECT ON CONTRACT PRICE : _____	EFFECTIVE DATE OF CHANGE : _____ SCHEDULE IMPACT: _____								
PAYMENT METHOD <input type="checkbox"/> ITEMISE SEPARATELY ON INVOICE FOR PAYMENT WHEN COMPLETE. <input type="checkbox"/> THE CHANGE IS PRICED ON <table style="display: inline-table; vertical-align: middle; margin-left: 20px;"> <tr> <td><input type="checkbox"/></td> <td>LUMP SUM BASIS</td> </tr> <tr> <td><input type="checkbox"/></td> <td>UNIT RATE BASIS PER _____ OF _____</td> </tr> <tr> <td><input type="checkbox"/></td> <td>DAY RATE BASIS AS STIPULATED IN CONTRACT</td> </tr> <tr> <td><input type="checkbox"/></td> <td>OTHERS (TO SPECIFY)</td> </tr> </table>		<input type="checkbox"/>	LUMP SUM BASIS	<input type="checkbox"/>	UNIT RATE BASIS PER _____ OF _____	<input type="checkbox"/>	DAY RATE BASIS AS STIPULATED IN CONTRACT	<input type="checkbox"/>	OTHERS (TO SPECIFY)
<input type="checkbox"/>	LUMP SUM BASIS								
<input type="checkbox"/>	UNIT RATE BASIS PER _____ OF _____								
<input type="checkbox"/>	DAY RATE BASIS AS STIPULATED IN CONTRACT								
<input type="checkbox"/>	OTHERS (TO SPECIFY)								
SUPPORTING DOCUMENTS : <table style="width:100%; border: none;"> <tr> <td style="width:50%;"><input type="checkbox"/> COST ESTIMATE</td> <td style="width:50%;"><input type="checkbox"/> OTHERS (SPECIFIC INSTRUCTIONS SUCH AS MANNING, EQUIPMENT, ETC.)</td> </tr> <tr> <td><input type="checkbox"/> MILESTONE PAYMENT AND WORK SCHEDULES</td> <td></td> </tr> </table>		<input type="checkbox"/> COST ESTIMATE	<input type="checkbox"/> OTHERS (SPECIFIC INSTRUCTIONS SUCH AS MANNING, EQUIPMENT, ETC.)	<input type="checkbox"/> MILESTONE PAYMENT AND WORK SCHEDULES					
<input type="checkbox"/> COST ESTIMATE	<input type="checkbox"/> OTHERS (SPECIFIC INSTRUCTIONS SUCH AS MANNING, EQUIPMENT, ETC.)								
<input type="checkbox"/> MILESTONE PAYMENT AND WORK SCHEDULES									
For and on behalf of CLIENT  _____ CLIENT's SIGNATURE  NAME : _____  DATE : _____	For and on behalf of CONTRACTOR  _____ CONTRACTOR's SIGNATURE  NAME : _____  DATE : _____								

(\*) All detailed technical and commercial documents shall be attached herewith

**APPROVING AND ISSUING OF CHANGE ORDER**

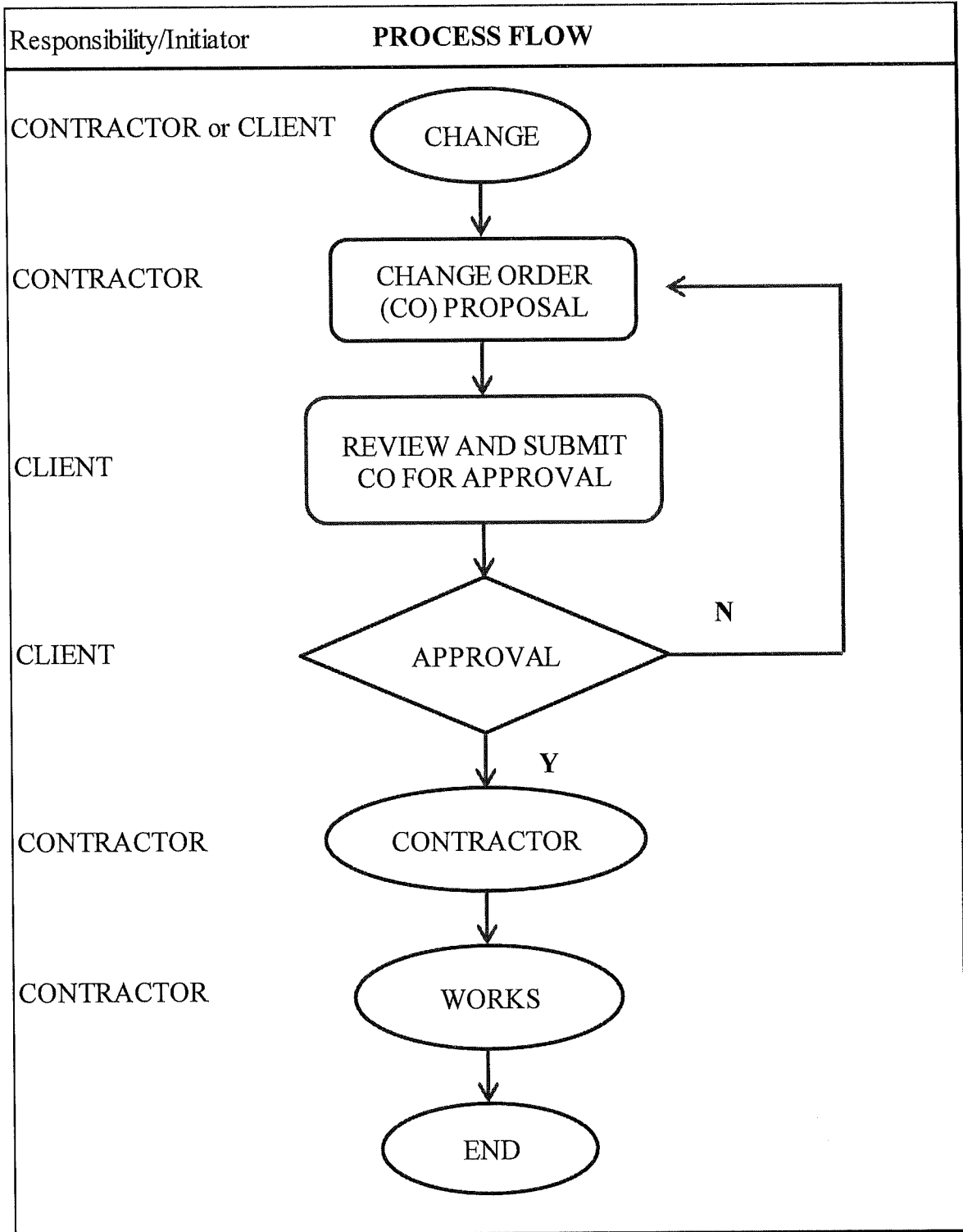



**EXHIBIT VI**

**INVOICE PROCEDURES AND ADMINISTRATION GUIDELINES**

— > A

**INVOICE PROCEDURES AND ADMINISTRATION GUIDELINES**

**TABLE OF CONTENTS**

<b><u>SECTION</u></b>	<b><u>TITLE</u></b>
VI -1.0	INVOICING PROCEDURES
VI -2.0	RELEASE ORDER
VI -3.0	CONTRACT CLOSURE
 <b><u>APPENDICES</u></b>	
APPENDIX VI -1	SPECIMEN FORM OF INVOICE
APPENDIX VI -2	BILLING STATEMENT
APPENDIX VI -3	WORK ORDER REQUEST
APPENDIX VI -4	WORK ORDER PROPOSALS
APPENDIX VI -5	RELEASE ORDER
APPENDIX VI -6	CONTRACT CLOSURE LETTER
APPENDIX VI -7	CONTRACT CLOSURE CERTIFICATE

## INVOICE PROCEDURES AND ADMINISTRATION GUIDELINES

### **VI -1.0 INVOICING PROCEDURES**

- VI-1.1 Invoices for WORKS performed shall be submitted in the invoicing format given in **APPENDIX VI-1** together with a copy of the Billing Statement per **APPENDIX VI-2** for every invoice submission. The statement shall reflect the total amount previously billed the current month billing and the total cumulative amount billed to date.
- VI-1.2 Invoices shall be submitted to the following address:-  
**PVEP-POC**  
15<sup>th</sup> Floor Victory Tower, 12 Tan Trao Street, Tan Phu Ward,  
District 7, Ho Chi Minh City  
Attn: **Manager, Finance and Accounts**
- VI -1.3 Invoices shall be submitted as per rates in **EXHIBIT IV – CONTRACT PRICE AND DERECIATION SCHEDULE** in accordance with **ARTICLE 7** entitled "Invoicing and Payment" of the **TERMS & CONDITIONS**.
- VI -1.4 All invoices shall be prepared on CONTRACTOR's letterhead. The letterhead shall include the name of the company, current address, telephone and facsimile numbers.
- VI -1.5 All invoices must indicate the following information but not limited to **CONTRACT** title and number, invoices number and date, location (well and rig name) where **SERVICES/WORK** are performed.
- VI -1.6 Debit Invoice and Credit Invoice shall be numbered differentially to distinguish between them.
- VI -1.7 No payment instruction which conflict with this **CONTRACT** shall be shown on the invoices. If any such conflict exists, the **CONTRACT** shall govern.
- VI -1.8 All invoices are to be submitted in two copies (one original and one duplicate copy) both complete with relevant supporting documents and properly stamped to distinguish between original and duplicate.
- VI -1.9 All invoices must be verified and signed by CONTRACTOR's **CONTRACT Administrator** designated in **ARTICLE 18**.
- VI -1.10 When invoices have been found to be undelivered, the **CONTRACTOR** shall submit certified true copies of the invoices and supporting documents duly signed by the **CONTRACTOR's CONTRACT Administrator** designated in **ARTICLE 18**.
- VI -1.11 All Invoices are to be submitted monthly, i.e., monthly billing and separate invoices must be submitted for each particular location, i.e., each well and/or each rig.
- VI -1.12 Billing shall be supported by verifiable milestone or time sheets (for monthly rate) approved by **CLIENT's Representative**. All other reimbursable cost are to be supported by appropriate cost summary sheets and verified by **CLIENT's Representative**.

A

**VI -2.0**     **RELEASE ORDER**

- VI-2.1     Whenever CLIENT requires work from CONTRACTOR, it shall issue to CONTRACTOR a Work Order Request as outlined in **APPENDIX VI-3** inviting the Contractor to submit a proposal based on specific scope of work.
- VI-2.2     CONTRACTOR shall submit its proposal to CLIENT all in accordance with **APPENDIX VI-4** headed Work Order Proposal hereof.
- VI-2.3     The terms and conditions for the Release Order (in the form given in **APPENDIX VI-5**) shall be the terms and conditions as contained in the contract.

**VI -3.0**     **CONTRACT CLOSURE**

CONTRACTOR shall submit to CLIENT a "CONTRACT CLOSURE LETTER" and "CONTRACT CLOSURE CERTIFICATE" as per format in **APPENDIX VI-6** and **APPENDIX VI-7**, respectively at the end of the duration of the CONTRACT.

**APPENDIX VI -1**

**SPECIMEN FORM OF INVOICE**

TO : PVEP-POC, 15<sup>th</sup> FLOOR  
VICTORY TOWER, 12 TAN  
TRAO STREET, DISTRICT 7, HO  
CHI MINH CITY

CONTRACTOR current  
address, telephone and  
facsimile numbers.

ATTN : Finance Manager

Contract Title :  
Contract No.

Invoice No.  
Invoice Date

Brief description on type of invoice, location (well & rig),  
month and year and etc.

---

Description of charges itemised in accordance with the rates  
set forth in the CONTRACT.

Total amount of the invoice

---

CONTRACTOR's Bank and  
Account Number as per  
ARTICLE 5

Verify and sign by  
CONTRACTOR's  
CONTRACT Administrator

Name

Date

**APPENDIX VI -2**

**PVEP-POC  
BILLING STATEMENT AS OF \_\_\_\_\_**

Invoice No.	Invoice Date	Invoice Amount	Brief Description of the Invoice	Cumulative Amount	Date of Submission	Amount Paid	Date Paid	Remarks

APPENDIX VI -3  
WORK ORDER REQUEST

	<b>WORK ORDER REQUEST</b>
<b>SERVICE</b> : _____	
<b>CONTRACT NO.</b> : _____	
<b>CONTRACT TITLE</b> : _____	
<b>CONTRACTOR</b> : _____	
<b>WORK LOCATON</b> : _____	
<b>DESCRIPTION OF WORK:</b>          	
<b>REFERENCE (DWGS/SPECS/DOCUMENTS/MINUTES OF MEETING):</b>	
<input type="checkbox"/> DRAWINGS	_____
<input type="checkbox"/> SPECIFICATIONS	_____
<input type="checkbox"/> OTHERS	_____

*A*

**APPENDIX VI -4**

**WORK ORDER PROPOSAL**

	<b>WORK ORDER PROPOSAL</b>
<p><b>SERVICE</b> :</p> <p><b>CONTRACT NO.</b> :</p> <p><b>CONTRACT TITLE</b> :</p> <p><b>CONTRACTOR</b> :</p> <p><b>WORK LOCATION</b> :</p>	
<p><b>DESCRIPTION OF WORK:</b></p>	
<p><b>REFERENCE(DWGS/SPECS/DOCUMENTS/MINUTES OF MEETING):</b></p> <p><b>DRAWINGS</b>    <input type="checkbox"/>    <b>SPECIFICATIONS</b>    <input type="checkbox"/>    <b>OTHERS</b>    <input type="checkbox"/></p>	
<p><b>WORK DURATION</b> :</p> <p><b>IMPACT ON CONTRACT SCHEDULE</b> :</p> <p><b>TOTAL ESTIMATED COST</b> :</p>	
	<p><b>EQ</b></p> <p><b>PER</b></p> <p><b>REI</b></p> <p><b>OT</b></p>

APPENDIX VI -5

RELEASE ORDER

**CONTRACTOR**

Address: \_\_\_\_\_

\_\_\_\_\_

\_\_\_\_\_

\_\_\_\_\_

\_\_\_\_\_

Your vendor number with us:

\_\_\_\_\_

**Release order**

RO number/date:

\_\_\_\_\_ / \_\_\_\_\_

Contact person/Telephone:

\_\_\_\_\_ / \_\_\_\_\_

Our fax number:

Our Reference:

\_\_\_\_\_

RE: Release Order for the stated items with the following Terms and Conditions.

-----

Terms of payt.: Within 45 days Due net

Currency: USD (United State Dollar) / VND (Vietnam Dong)

Item	Quantity	Unit	Descriptions	Unit Price	Net Value
------	----------	------	--------------	------------	-----------

\_\_\_\_\_

Deliv. Date: \_\_\_\_\_

Rel. ord. against contract \_\_\_\_\_ Item \_\_\_\_\_

\_\_\_\_\_

Total Order value USD/ VND

Accepted by

Approved By

-----

-----

Tender No. PVEPPOC-25-10205

Handwritten signature

**APPENDIX VI -6**

**CONTRACT CLOSURE LETTER**

CONTRACTOR : \_\_\_\_\_

CONTRACT NO. : \_\_\_\_\_

CONTRACT TITLE : \_\_\_\_\_

Dear Sir,

For administrative purpose we wish to close and archive the account of this CONTRACT and therefore request you to sign in duplicate the attached Contract Closure Certificate. Upon signing, please return one original copy to us for our record and retention.

The purpose of the certificate is to confirm the total sum of money that has been paid by CLIENT under the CONTRACT and to confirm that no further sums are payable by CLIENT. Please enter the appropriate figure in spaces provided in the attached Certificate.

Yours faithfully,  
For and on behalf of CLIENT.

\_\_\_\_\_  
Signature

\_\_\_\_\_  
Name

\_\_\_\_\_  
Designation

\_\_\_\_\_  
Date

**APPENDIX VI -7**

**CONTRACT CLOSURE CERTIFICATE**

With reference to CONTRACT No. \_\_\_\_\_ dated \_\_\_\_\_ 20\_\_\_\_,

between undersigned CONTRACTOR, \_\_\_\_\_  
( Name of CONTRACTOR )

and \_\_\_\_\_  
( Name of COMPANY )

\_\_\_\_\_

for \_\_\_\_\_  
( Title )

In consideration of USD/ VND \_\_\_\_\_ as per final payment under the CONTRACT, the CONTRACTOR hereby unconditionally releases and forever discharges CLIENT and CLIENT premises and property from all claims, liens and obligations of every nature arising out of or in connections with performance of the CONTRACT and all amendments thereto.

The CONTRACT agrees to indemnify and hold CLIENT harmless from and against all cost, losses, damages, claims from any cause of action, judgements and expenses, including legal costs arising out of or in connections with claims against CLIENT which claims arise of the performance of the WORK under the CONTRACT and which may be asserted by CONTRACTOR or any of its sub-Contractors or any of their representatives, officers, agents or employees.

The foregoing shall not relieve the CONTRACTOR of his obligations under the provision of the CONTRACT, which by their nature survive completion of the WORK including, without limitation, warranties, guarantees and indemnities.

Executed this \_\_\_\_\_ day of \_\_\_\_\_ 20\_\_\_\_.  
For and on behalf of ( Name of CONTRACTOR)

\_\_\_\_\_  
Signature

\_\_\_\_\_  
Name

A



**EXHIBIT VII**

**MUTUAL HOLD HARMLESS AGREEMENT**

This Mutual Hold Harmless Agreement (hereinafter referred to as the "AGREEMENT") is made and entered into this \_\_\_\_ day of \_\_\_\_\_, \_\_\_\_ by and between <<CONTRACTOR>>, a corporation incorporated and existing under the laws of the S.R. Vietnam (hereinafter referred to as "CONTRACTOR"), whose address is ....., S.R. Vietnam and [*Enter the name of the other contractor's legal entity that will enter into this Agreement.*], a \_\_\_\_\_ company (hereinafter referred to as "OTHER CONTRACTOR"), whose address is \_\_\_\_\_.

In this AGREEMENT, CONTRACTOR and OTHER CONTRACTOR shall also be referred to individually as "PARTY" or collectively as "PARTIES".

**WHEREAS, DOMESTIC PETROLEUM OPERATING BRANCH - PETROVIETNAM EXPLORATION PRODUCTION CORPORATION LIMITED**, a company organized and existing under the Laws of S.R Vietnam and having its registered address at 15<sup>TH</sup> Floor Victory Tower, 12 Tan Trao Street, Tan Phu Ward, District 7, Ho Chi Minh City, S.R. Vietnam, (hereinafter referred to as "CLIENT") has entered into separate agreements with CONTRACTOR and OTHER CONTRACTOR for the provision of certain work, services, equipment, materials or products as set forth in CONTRACTOR's and OTHER CONTRACTOR's respective contracts with CLIENT for Exploration, Development and Production of hydrocarbon activities, offshore S.R. Vietnam; and

WHEREAS, CONTRACTOR and OTHER CONTRACTOR wish to apportion certain liabilities between themselves in the manner provided for in this AGREEMENT; and

WHEREAS the PARTIES acknowledge and agree that third parties may wish to become parties to this arrangement and the PARTIES agree that third parties may do so by executing a Counterpart.

NOTWITHSTANDING ANYTHING TO THE CONTRARY INCLUDING BUT NOT LIMITED TO THAT CONTAINED TO THE CONTRARY IN EACH OF CONTRACTOR'S AND OTHER CONTRACTOR'S RESPECTIVE CONTRACTS WITH CLIENT WHICH HAVE BEEN INDIVIDUALLY AGREED AND EXECUTED BY AND BETWEEN CONTRACTOR AND CLIENT AND OTHER CONTRACTOR AND CLIENT, CONTRACTOR AND OTHER CONTRACTOR AGREE AS FOLLOWS:

1. For the purpose of this AGREEMENT, the following definitions shall apply:

- A. "AFFILIATES" shall mean with respect to a party, any other company or entity controlling, controlled by that party. As used in this definition, the term "control, controlling or controlled" means: (a) with respect to any company or other entity having voting shares or the equivalent and elected directors, managers or officers performing similar functions, the ownership or power to vote more than 50% of the shares, or the equivalent, in the election of directors, managers or officers performing similar functions, and (b) with respect to any other entity, the ability to direct its business and affairs.
- B. "CLAIMS" shall mean any and/or all claims, demands, causes of action, liabilities, damages, judgments, fines, penalties, awards, losses, costs, and expenses (including, without limitation, attorneys' fees and costs of litigation) arising out of, or in connection with, the work, services, equipment, materials and/or products to be provided by CONTRACTOR and/or OTHER CONTRACTOR in their respective contracts with CLIENT.
- C. "CONTRACTOR INDEMNITEES" shall mean CONTRACTOR, its AFFILIATES its subcontractors of any tier, and their AFFILIATES, and the officers, directors, employees and invitees of all of the foregoing.
- D. "OTHER CONTRACTOR INDEMNITEES" shall mean OTHER CONTRACTOR, its AFFILIATES, its subcontractors of any tier and their AFFILIATES, and the officers, directors, employees and invitees of all of the foregoing.
2. CONTRACTOR shall be liable for, and shall hold OTHER CONTRACTOR INDEMNITEES harmless from and against any damage to or loss of CONTRACTOR INDEMNITEES' property and/or equipment. CONTRACTOR shall be liable for, and hereby agrees to release, indemnify, defend and hold OTHER CONTRACTOR INDEMNITEES harmless from and against any and all CLAIMS asserted by or in favor of any member of CONTRACTOR INDEMNITEES on account of personal or bodily injury, illness, sickness, disease or death (including, without limitation, loss of services or wages or loss of consortium or society) or on account of loss of, damage to or destruction of real or personal property.
3. OTHER CONTRACTOR shall be liable for, and shall hold CONTRACTOR INDEMNITEES harmless from and against any damage to or loss of OTHER CONTRACTOR INDEMNITEES' property and/or equipment. OTHER CONTRACTOR shall be liable for, and hereby agrees to release, indemnify, defend and hold CONTRACTOR INDEMNITEES harmless from and against any and all CLAIMS asserted by or in favor of any member of OTHER CONTRACTOR INDEMNITEES on account

of personal or bodily injury, illness, sickness, disease or death (including, without limitation, loss of services or wages or loss of consortium or society) or on account of loss of, damage to or destruction of real or personal property.

4. Notwithstanding anything contained in this AGREEMENT to the contrary, CONTRACTOR shall be liable for, and hereby agrees to release, indemnify, defend and hold OTHER CONTRACTOR INDEMNITEES harmless from and against any CLAIMS for indirect, incidental, special, punitive, exemplary or consequential damages or losses (whether foreseeable or not at the date of this AGREEMENT), which shall include, without limitation, damages or losses for lost production, lost revenue, lost product, lost profit, lost business or business interruptions brought by or in favor of any member of CONTRACTOR INDEMNITEES.
5. Notwithstanding anything contained in this AGREEMENT to the contrary, OTHER CONTRACTOR shall be liable for, and hereby agrees to release, indemnify, defend and hold CONTRACTOR INDEMNITEES harmless from and against any CLAIMS for indirect, incidental, special, punitive, exemplary or consequential damages or losses (whether foreseeable or not at the date of this AGREEMENT), which shall include, without limitation, damages or losses for lost production, lost revenue, lost product, lost profit, lost business or business interruptions brought by or in favor of any member of OTHER CONTRACTOR INDEMNITEES.
6. Third party liability
  - 6.1. The CONTRACTOR shall be liable for, and hereby agrees to release, indemnify, defend and hold OTHER CONTRACTOR INDEMNITEES harmless from and against any claims for personal injury including death or disease or loss of or damage to the property, real or personal, or consequential loss as defined in Paragraphs 4 and 5 above of any third party to the extent that any such injury, loss or damage is caused by the negligence or breach of duty (whether statutory or otherwise) of the CONTRACTOR. For the purposes of this Paragraph, "third party" shall mean any party which is not CLIENT, a member of CONTRACTOR INDEMNITEES or OTHER CONTRACTOR INDEMNITEES.
  - 6.2. The OTHER CONTRACTOR shall be liable for, and hereby agrees to release, indemnify, defend and hold CONTRACTOR INDEMNITEES harmless from and against any claims for personal injury including death or disease or loss of or damage to the property, real or personal, or consequential loss as defined in Paragraphs 4 and 5 above of any third party to the extent that any such injury, loss or damage is caused by the negligence or breach of duty (whether statutory or otherwise) of the OTHER CONTRACTOR. For the purposes of

this Paragraph, "third party" shall mean any party which is not CLIENT, a member of CONTRACTOR INDEMNITEES or OTHER CONTRACTOR INDEMNITEES.

7. The liabilities, releases and indemnities set forth in Paragraphs 2 through 5 of this AGREEMENT shall apply to any CLAIMS without regard to the cause(s) thereof including, without limitation, pre-existing conditions, whether such conditions be patent or latent, imperfection of material, defect or failure of products or equipment, breach of representation or warranty (express or implied), ultra-hazardous activity, strict liability, tort, breach of contract, breach of duty (statutory or otherwise), breach of any safety requirement or regulations, or the negligence (of any kind) or other legal fault or responsibility of any person or party (including, without limitation, the indemnified or released person or party), whether such negligence is sole, joint or concurrent, active or passive. A PARTY's obligation to release, indemnify, defend and hold the other PARTY harmless pursuant to this AGREEMENT shall not apply to the extent such obligation relates to a loss, damage or liability resulting from the willful misconduct of the PARTY and/or its INDEMNITEES, i.e. CONTRACTOR INDEMNITEES or OTHER CONTRACTOR INDEMNITEES respectively, with the right to be released, indemnified, defended and held harmless.
8. To the extent of each PARTY's respective release and indemnity obligations under this AGREEMENT, each PARTY shall cause its insurers to waive any rights of subrogation against the other PARTY and its INDEMNITEES, i.e. CONTRACTOR INDEMNITEES or OTHER CONTRACTOR INDEMNITEES respectively.
9. This AGREEMENT is executed on the date first written above and shall remain in effect until the provision of the work, services, equipment, materials or products to be furnished by each PARTY under its respective contract with CLIENT has been completed or until termination of each PARTY's respective contract with CLIENT, whichever first occurs. However, such termination shall not be effective and the PARTIES shall be bound to their obligations hereunder for any CLAIMS arising or asserted after the date of termination from an event occurring during the term hereof.
10. This AGREEMENT shall be construed in accordance with, interpreted under and governed by the substantive laws of Vietnam, excluding any conflicts laws or choice of law rules.

The PARTIES agree that any controversy, claims or disputes (the "Dispute") arising out of or relating to this AGREEMENT, including any questions regarding its existence, validity or termination, shall be finally resolved by final and binding arbitration before Vietnam International Arbitration Centre ("VIAC") at the Chamber of Commerce and Industry of

Vietnam (VCCI) in accordance with its Rules of Arbitration (“**VIAC Rules**”) for the time being in force which are deemed to be incorporated by reference in this Paragraph. The Tribunal shall consist of three (3) arbitrators, with each PARTY appointing one arbitrator, and the two arbitrators so appointed appointing the third arbitrator who shall act as Chair (the “**Tribunal**”). The place of arbitration shall be Ho Chi Minh City, S.R. Vietnam. The language to be used in the arbitral proceedings shall be English. The PARTIES shall treat all matters relating to the arbitration as confidential. Subject to either PARTY’s right or duty to cooperate fully with the competent authorities or stock exchanges, the PARTIES understand and agree that this confidentiality obligation extends to information concerning the fact of any request for arbitration, any ongoing arbitration, as well as all matters discussed, discovered, or divulged, (whether voluntarily or by compulsion) during the course of such arbitration proceeding. It is the desire of the PARTIES that any Dispute is resolved efficiently and fairly and the Tribunal shall act in a manner consistent with these intentions.

11. The PARTIES expressly agree that the liabilities and indemnities under this AGREEMENT shall be severable and additional to, and shall not in any case be construed as replacement and/or prejudice to, those provided for in the PARTIES’s respective contracts with the CLIENT. If any provision (of portion thereof) of this AGREEMENT shall be declared invalid, illegal or unenforceable, the remaining provisions shall not be affected thereby, and this AGREEMENT shall be construed as if such invalid, illegal or unenforceable provision (or portion thereof) had never been contained herein.
12. Each PARTY shall, upon request to CLIENT, receive a copy of every Mutual Hold Harmless Agreement which is executed by any of CLIENT’s contractors or any third parties as defined above in Paragraph 6.

IN WITNESS WHEREOF, the PARTIES warrant, individually, that they have the full rights, power and authority to enter into this AGREEMENT on behalf of the respective PARTIES hereto.



<<CONTRACTOR>>

By: \_\_\_\_\_

Name: \_\_\_\_\_

Title: \_\_\_\_\_

Date: \_\_\_\_\_

[Enter name of the OTHER  
CONTRACTOR legal entity that will enter  
this AGREEMENT.]

By: \_\_\_\_\_

Name: \_\_\_\_\_

Title: \_\_\_\_\_

Date: \_\_\_\_\_

## EXHIBIT VIII

### HEALTH, SAFETY AND ENVIRONMENT REQUIREMENT

This EXHIBIT provides a quick reference to requirements HSE Management System applicable to the CONTRACT. The list is by no means definitive and the CLIENT Safety Manual together with other policies, procedures and special instructions, shall also apply to this CONTRACT.

When this EXHIBIT and its APPENDIX refers to the CONTRACTOR and the CONTRACTOR's Personnel, this shall also be taken to refer to subcontractors of the CONTRACTOR and the Subcontractor's Personnel.

CONTRACTOR shall prepare the COVID-19 Preparedness & Response Plan and must cover all issues and cost related to the Covid-19 throughout the duration of contract. This Plan has been established for the Bids and contract in accordance with National Steering Committee for Prevention and Control of Covid-19 and CLIENT's Guideline. Prior to performing Bids or contract, Contractor send The COVID19 Preparedness & Response Plan to CLIENT for reviewing and approving. Moreover, in the event that there is mandatory quarantine requirement from the government of Vietnam during the performance period of the contract, no CONTRACTOR's personnel and/or equipment rates during such mandatory quarantine period shall be applied and CONTRACTOR shall pay for meal & accommodation, appointed by the authority, & testing in Vietnam. If any of CONTRACTOR's personnel is concluded infected to the aforesaid virus and/or disease, CONTRACTOR shall immediately send replacement and bear all the related cost including but not be limited to CONTRACTOR's personnel & equipment time waiting for such personnel substitute, mob/demob cost, meal & accommodation and testing and medical treatment cost of the infected personnel

#### VIII-1.0 HSE POLICY & PROGRAM

CONTRACTOR shall have in place, prior to the commencement of this CONTRACT, a written policy on Safety, Health and Environment. This policy shall be of a standard comparable to CLIENT's policy and shall be actively supported and endorsed by CONTRACTOR's Management. A copy to be submitted to CLIENT prior to the commencement of the operation.

In addition, CONTRACTOR shall also have safety targets and objectives, paying particular attention to accident prevention, written action plans clearly indicating how safety objectives shall be achieved and a system to appraise risk and problem areas to ensure that the overall safety program is being carried out and complied with.

CONTRACTOR shall submit the Monthly Safety Statistics Report as per format shown in **APPENDIX VIII-3.**

#### VIII-2.0 ACCIDENT REPORTING & INVESTIGATION

VIII-2.1 Accident is defined as any unintentional or unplanned event or condition which has or could have resulted in injury to a person, loss or damage to equipment, plant or property, or pollute to environment.

VIII-2.2 CLIENT requires that all accidents, no matter how trivial, must be reported to the CLIENT Representative. CONTRACTOR shall ensure that its employees are aware of this mandatory requirement.

CONTRACTOR shall be responsible to investigate, in a professional manner, all accidents that occur during the performance of the WORKS. The investigation report shall be made available to CLIENT when requested. CONTRACTOR shall also be responsible for assisting CLIENT in accident investigations, if so required.

### VIII-3.0 ALCOHOL/DRUG POLICY

- VIII-3.1 CONTRACTOR warrants that its employees, agents and subcontractors shall not perform any WORKS for CLIENT while under the influence of alcohol or any controlled substance. CONTRACTOR, its employees, agents, and subcontractors shall not misuse legitimate drugs or possess, use, distribute, or sell illicit or unprescribed controlled substances or drugs on CLIENT business or premises. CONTRACTOR shall adopt and enforce WORKS rules and policies in order to assure compliance with these obligations.
- VIII-3.2 CLIENT reserves the right to conduct alcohol and/or drug tests on the CONTRACTOR employees, agents, or subcontractors while on premises owned or controlled by CLIENT's where reasonable cause exists.
- CLIENT also reserves the right to conduct searches for possession of drugs and/or alcohol on the person, vehicles, and other property of CONTRACTOR, its employees, agents or subcontractors while on premises owned or controlled by CLIENT. Any person who refuses to cooperate with any such search shall be removed from the premises and not permitted to return.
- VIII-3.3 CONTRACTOR shall require its employees, agents and subcontractor to submit to medical evaluation or alcohol or drug testing where cause exists to suspect alcohol or drug use.
- VIII-3.4 CONTRACTOR warrants that any employee, agent or subcontractor who either: (1) refuses to participate in medical evaluation or alcohol or drug tests, or (2) tests positive for alcohol or a controlled substance, shall be removed from the premises and not be permitted to perform any WORKS for CLIENT.
- VIII-3.5 In the event CONTRACTOR is unable to comply with these obligations, CLIENT shall have the option to terminate this CONTRACT forthwith. CONTRACTOR shall be entitled to payment for WORKS performed to the date of such termination, but no payment shall be made for lost profit, unused materials, or bonus, if applicable.

### VIII-4.0 PERMIT-TO-WORK SYSTEM

All WORKS carried out by CONTRACTOR's Personnel must be in accordance with the CLIENT "Permit-To-Work System".

The CONTRACTOR is obligated to request a copy of this publication and ensure that its personnel have a thorough knowledge of its content.

#### VIII-4.1 Hot-Work

All Hot-Work must be carried out in strict compliance accordance with the CLIENT's "Permit-To-Work System" and attention must be given to the following:

VIII-4.1.1 Only trained, competent personnel shall be engaged for any Hot-Work.

VIII-4.1.2 The personnel carrying out the WORKS must have a copy of the authorized Hot-Work permit displayed at the Work Site(s) or Work Area. This permit shall clearly state the nature of the WORKS to be carried out, safety precautions to be taken regarding fire equipment, personal protective equipment, etc, and necessary tests for the presence of combustible gases.

VIII-4.1.3 The CONTRACTOR, in accordance with the "Permit-To-Work System" shall dedicate a trained fire-watcher to the personnel performing the WORKS. The duties of the fire-watcher are as follows (if applicable):

- 1) To ensure that the Work Site(s) or Work Area and adjacent areas are maintained in a safe condition (e.g., sparks are not falling onto unprotected area).
- 2) To warn the workers of any hazard developing in the Work Site(s) or Work Area.
- 3) To isolate the equipment in the event of an emergency.
- 4) To quickly extinguish any smouldering material which may develop into a fire.
- 5) To be able to establish contact with the Control Room if an emergency occurs.
- 6) To ensure that a minimum of one dry chemical fire extinguisher, one pressurized fire hose, and a fire blanket are available at the Work Site(s) or Work Area and be capable of using this equipment if required to do so.
- 7) To ensure that the Work Site(s) or Work Area is clear of all flammable and combustible material prior to commencement of WORKS.

## VIII-5.0 SAFETY TRAINING & SUPERVISION

VIII-5.1 Prior to the commencement of the WORKS, CONTRACTOR shall at its own expense ensure that its personnel have been given the necessary basic safety, fire-fighting, sea- survival, and job related training required by law and CLIENT as outlined in **APPENDIX VIII-2**. Such training shall be carried out at training establishments approved by CLIENT as listed in **APPENDIXVIII-2**. Certification of training shall be provided to CLIENT prior to the commencement of WORKS.

Upon request from CONTRACTOR, CLIENT may approve training provided by training establishments other than those specified in **APPENDIXVIII-2** provided CONTRACTOR furnishes CLIENT a copy of the course/program syllabus and contacts for the establishment.

## VIII-6.0 PERSONAL PROTECTIVE EQUIPMENT

VIII-6.1 CONTRACTOR shall at its own expense be responsible for providing its personnel with CLIENT approved Personal Protective Equipment suitable for the task being carried out.

VIII-6.2 CONTRACTOR shall ensure that its personnel and/or other personnel assigned by the CONTRACTOR to the performance of the WORKS wear the following minimum Personal Protective Equipment when engaged in WORKS or when in an on-site area where such equipment is required:

- 1) Coveralls,
- 2) Safety footwear with steel toe cap and steel mid sole,
- 3) Safety helmet, and
- 4) Safety glasses.

VIII-6.3 Other Personal Protective Equipment that is required, depending on the nature of the job to be carried out and the likely hazards encountered in certain WORKS environments, including :

- 1) ear muff/plugs,
- 2) gloves,
- 3) face shield/Vsor,
- 4) respiratory protection, and
- 5) fall protection.



VIII-6.4 CONTRACTOR must ensure that the standard Personal Protection Equipment such as gloves, apron and respiratory protection equipment issued to its personnel complies with the recommendations contained in the manufacturer's "Material Safety Data Sheet" for the product.

**NOTE:** In some circumstances this may require the wearing of self-contained or air-line breathing apparatus and the CONTRACTOR must ensure that these employees are thoroughly familiar with all types of respiratory protection.

VIII-6.5 A list of CLIENT Approved Personal Protective Equipment is contained in **APPENDIX VIII-1.**

#### VIII-7.0 **SAFETY DRILL**

VIII-7.1 The CONTRACTOR shall ensure that its personnel are thoroughly familiar with all site alarms, their muster station and, where applicable, the location of their lifeboat.

VIII-7.2 CONTRACTOR's Personnel should rapidly acquire a thorough knowledge of site escape routes including alternative routes if the primary route happens to be blocked.

VIII-7.3 The employees, servants or agents of the CONTRACTOR when working offshore or onshore shall participate in appropriate emergency drills and emergency response training (e.g., fire, muster and boat drills, instructions in survival, life saving, and fire fighting).

#### VIII-8.0 **SAFETY MEETINGS**

VIII-8.1 The CONTRACTOR's Personnel shall, from time to time, be requested to attend CLIENT safety meetings. Attendance at these meetings is mandatory and does not relieve the CONTRACTOR of the obligation to hold its own safety meetings as outlined in CONTRACTOR's safety policy.

#### VIII-9.0 **MEDICAL WELFARE**

VIII-9.1 CONTRACTOR shall ensure that all its employees and Subcontractor's employees engaged in the WORKS are medically fit and healthy. Any medical disabilities, including such disabilities which CONTRACTOR may consider will not adversely influence the employee's ability to perform his role in the WORKS, shall be reported to CLIENT prior to the start of the WORKS. CONTRACTOR, if requested by CLIENT, shall provide medical certificates for CONTRACTOR and Subcontractor personnel.

VIII-9.2 CONTRACTOR shall, at no cost to CLIENT, be responsible for the medical welfare of its own and Subcontractor's employees and shall take care of arrangements for medical attendance, treatment or hospitalization if and when necessary and will arrange suitable insurance coverage for such contingencies. In cases of emergency,

CLIENT may make or provide for, the necessary emergency arrangements, the costs of which shall be reimbursed to CLIENT by CONTRACTOR.

#### VIII-10.0 **TOOLS & EQUIPMENT**

Equipment and tools shall only be operated by competent personnel.

CONTRACTOR shall ensure that all CONTRACTOR's machinery, equipment, facilities, and other items associated with or utilized in the WORKS are maintained in a safe, sound and proper condition, and comply with laws, regulations, and CLIENT requirement.

VIII-10.1 CONTRACTOR shall ensure that all tools and equipment and temporary facilities and other items used in the WORKS, whether purchased, rented or otherwise provided by CONTRACTOR are in a safe, sound and good condition and are capable of performing the function for which they are intended.

VIII-10.2 If any tool or item of equipment is in the judgement of CLIENT unsafe or incapable of doing the WORKS for which it is intended, CONTRACTOR shall repair and/or replace such defective tools and equipment used in the WORKS at CONTRACTOR's own expense.

#### VIII-10.3 **DIESEL ENGINE DRIVEN PUMPS, COMPRESSORS, WELDINGSET,ETC.**

VIII-10.3.1 Diesel engine driven pumps, compressors, welding sets, and any other diesel engine driven equipment must be located in a safe area and must be fitted with a water-cooled exhaust and approved spark arrestor as a minimum requirement.

VIII-10.3.2 Any such equipment must be well maintained and in good operational order and prior to use should be inspected by CLIENT Representative.

VIII-10.3.3 If the equipment is to be used offshore, it shall be inspected prior to shipment to the offshore site.

VIII-10.3.4 If such equipment is to be used in a hazardous area classified as a Zone 1 or 2 areas, the equipment must comply fully with EEMUA 107 requirements (Recommendations For The Protection Of Diesel Engines Operating in Hazardous Areas). The said requirements were formerly contained in an Oil Companies Materials Association (OCMA) publication.

#### VIII-10.4 **ELECTRICALLY POWERED PORTABLE TOOLS AND EQUIPMENT**

VIII-10.4.1 Only trained and competent personnel shall use portable electrically powered tools and equipment.

VIII-10.4.2 Electrically powered portable tools and equipment shall be 110 volts centre-tapped or 240 volt tools subject to the following conditions:

- 1) they shall be double insulated, and
- 2) the power source shall be equipped with an earth leakage circuit breaker/ground fault interrupter (ELCB/GFI) with a trip sensitivity not exceeding ten milli-amps (10mA).

VIII-10.4.3 A written procedure for checking and maintaining portable electrically powered hand tools and equipment shall be in place. Any defective electrical tool and equipment shall be immediately prohibited from further use until it has been satisfactorily repaired. Defective items which are no longer serviceable shall be removed from storage or use and scrapped. CONTRACTOR shall maintain accurate records regarding the maintenance and disposal of such equipment. The CONTRACTOR shall appoint a person(s) to be responsible for such maintenance.

#### VIII-10.5 **HANDTOOLS**

VIII-10.5.1 CONTRACTOR shall ensure that all tools supplied are in good condition and fit for their intended use.

VIII-10.5.2 Damaged tools which are unfit for use must be removed from service immediately and if they cannot be repaired, they must be scrapped.

VIII-10.5.3 CONTRACTOR's employees must be fully instructed regarding the use of the correct tool for a particular job, (e.g. The use of a cheater bar or piece of pipe to increase the length of a pipe wrench handle is totally unacceptable. A larger pipe wrench must be used)

#### VIII-11.0 **HOUSEKEEPING**

VIII-11.1 CONTRACTOR shall ensure that its personnel keep and maintain good housekeeping practices at the Work Site to eliminate all hazards or control hazardous conditions in order to avoid injury to workers throughout the duration of the WORKS. CONTRACTOR shall know what the hazards are and how to guard against the hazards, the kind of which shall include unsafe acts and unsafe conditions.

VIII-11.2 In order to reduce the risk of fire, waste materials and garbage shall not be allowed to accumulate and as a minimum, must be disposed of on a daily basis and in an appropriate manner.

VIII-11.3 In order to minimize site hazards (such as trips, slips, falls, etc.), access ways must be kept clear of electrical cables, wires, metal pipes, scaffold boards and other materials and equipment.

VIII-11.4 All gaps such as that caused by the removal of gratings must be adequately roped off and the grating stored so that it does not become an "obstruction and trip hazard".

VIII-12.0 **ENVIRONMENTAL PROTECTION**

- VIII-12.1 CONTRACTOR shall pay due regard to the environment by acting to protect air, water, animal and plant life from adverse effects of CONTRACTOR's activities, and to minimize any adverse effects which may arise from such operations in accordance with government and CLIENT environmental policies.
- VIII-12.2 CONTRACTOR shall adhere to existing national statutory regulations concerning discharges resulting from the performance of the WORKS.
- VIII-12.3 CONTRACTOR and its Subcontractors shall not, under any circumstances dump, throw or dispose of any refuse, oily wastes, toxic substance, debris or garbage into the sea. CONTRACTOR shall provide containers in which all refuse is to be placed and shall dispose of such refuse in accordance with existing laws and regulations and at no additional cost to CLIENT.
- VIII-12.4 CONTRACTOR shall ensure that its employees and its Subcontractors, and their employees are fully aware of the above and CONTRACTOR shall enforce such regulations to the satisfaction of CLIENT.

VIII-13.0 **LAND TRANSPORTATION**

- VIII-13.1 CONTRACTOR's Personnel travelling to and from onshore work site(s) shall use proper and safe means of transport.
- VIII-13.2 Such transport shall comply with the Vietnamese traffic rules and regulations.
- VIII-13.3 Transportation of the CONTRACTOR's personnel in open trucks is prohibited unless the truck is fitted with seats and certified to carry passengers. All speed limits must be adhered to.

VIII-14.0 **TYPICAL HAZARDS**

- VIII-14.1 CONTRACTOR is required to provide the tools and equipment as well as written procedure to ensure all hazards listed in **APPENDIX VIII-4** are addressed.
- VIII-14.2 CONTRACTOR is required to develop an action plan (or written procedure) for each mentioned hazard (where and as and when applicable) prior to commencing the WORKS.

**APPENDIX VIII-1**

**APPROVED PERSONAL PROTECTIVE EQUIPMENT**

1.0 **SAFETY SPECTACLES**

**BRAND**                    **MODEL NO.**   **STANDARD**

KING OR EQUIVALENT

ANSI Z78.1

2.0 **SAFETY BOOTS**

2.1 **FOR GENERAL USE**

**BRAND****MODEL NO.****STANDARD**

KRUSHERS OR EQUIVALENT

AS/NZS 2210.3: 2000

ASTM F2413-05

EN 345-1

2.2 **FOR CHEMICAL USE**

RUBBER BOOT - VIETNAM

3.0 **COVERALL**

FABRIC 100% COTTON

4.0 **HAND PROTECTION**

4.1 FABRIC GLOVES WITH PLASTIC DOT

VIET NAM

4.2 WOOL GLOVES WITH PLASTIC DOT

VIETNAM

4.3 WELDER GLOVES

COW-HIDE, COLOR REUST, DELUXE, COTTON LINING

5.0 **HEARING PROTECTION**

5.1 EAR MUFFS MOUNTED ON SAFETY HELMETS

PROTECTOR  
OR EQUIVALENT

CLASS 5

ANSI S3.19-1974/CSA Z94.2



5.2 EAR PLUGS

3M EAR PLUGS 1110

6.0 HEAD PROTECTION

BULLARD  
OR EQUIVALENT CLASS E, TYPE I ANSI/ISEA Z89.1-2009

7.0 EYE/FACE PROTECTION

7.1 CHEMICAL SPLASH GOGGLES

BRANDMODEL NO. STANDARD

CONDOR OR EQUIVALENT 1VT70

7.2 FACE SHIELD

MSA OR EQUIVALENT 488126 ANSI Z87

7.3 WELDERS GOGGLES

GRAINGER OR EQUIVALENT PN 1UYF9,

8.0 OTHERS

8.1 SAFETY HARNESS/LIFEBELT

SALA OR EQUIVALENT 1107802 ANSI Z359.1  
OSHA  
ANSI Z359.3  
ANZI Z359.4

8.2 DUST MASK (DISPENSABLE)

VIETNAM

8.3 RAIN WEAR

VIETNAM

8.4 WELDERS APRON

ANSELL OR EQUIVALENT

8.5 CHEMICAL - HANDLING APRON

ANSELL OR EQUIVALENT

8.6 WORK VEST

STEARNS OR EQUIVALENT  
(TYPE V)

I223

US COAT GUARD  
APPROVED



APPENDIX VIII-2

APPROVED SAFETY TRAINING INSTITUTIONS

	<u>Name of Institution</u>	<u>Courses</u>
1.	Sri Bima Maritime Training Centre, Miri, Sarawak	o Sea Survival & Fire Training.
2.	Terengganu Safety Training Centre (TSTC), Teluk Kalong Kemaman, Terengganu	o Safety & Sea Survival Fire Training HUET
3.	Kerteh Fire Services East Coast Regional Office PETRONAS Kerteh, Terengganu	o Fire Training
4.	Robert Gordon Institute of Technology (RGIT) Aberdeen, Scotland	o Sea Survival & Fire Training. HUET
5.	Petroleum Training Assoc. North Sea (PETANS) Lowestoft, England	o Sea Survival & Safety HUET
6.	Maritime Training Centre (MTC) Vlissingen, Holland	o Sea Survival & Safety o HUET
7.	Rotterdam International Safety Centre (RISC), Holland	o Fire Training
8.	Industrial Foundation For Accident Prevention Woodside Offshore Petroleum Perth, Australia	o Sea Survival, Fire o Training & Safety o HUET
9.	Alert Disaster Control (Asia)	o Safety and Sea Singapore o Survival. Fire Training.
10.	Petrovietnam Safety Training Centre Vung Tau, Vietnam	o Safety and Sea Survival o Fire Training o HUET o HUET
11.	PVD Training Vung Tau, Vietnam	o Safety and Sea Survival o Fire Training.

NOTE:In certain cases it may not be practical to send personnel to some of the above training establishments due to the logistical problem. However, a number of the above establishments can be contracted to train CONTRACTOR's Personnel at the Work-Site(s).

**LIST OF APPROVED MEDICAL EXAMINERS**

1. SOS International Centre  
65 Nguyen Du, Dist 1, HCMC, Vietnam.
2. Columbia Saigon Clinic  
08 Alexandre de Rhodes, Dist 1, HCMC, Vietnam
3. VSP Medical Centre  
Vietsovpetro Clinic  
5 Area, Ward 7, Vung Tau City
4. Victoria Health Care  
79 Dien Bien Phu, Dist 1, HCMC, Vietnam
5. Le loi Hopital  
22 Le Loi Street, Vung Tau City



**APPENDIX VIII-3**

**MONTHLY SAFETY STATISTICS REPORT**

**TO: PETROVIETNAM DOMESTIC EXPLORATION PRODUCTION  
OPERATING COMPANY LIMITED**

15<sup>th</sup> Floor, Phu My Hung Petroleum Finance Trade Center, 12 Tan Trao  
Street, District 7, Ho Chi Minh City, S.R. Vietnam

**ATTN :**

MONTH : \_\_\_\_\_ CONTRACT NO. \_\_\_\_\_  
CONTRACTOR : \_\_\_\_\_ WORK AREA : \_\_\_\_\_

No.	Description	Units	Area
1	Total Man-hours worked (including contractor man-hours)	hrs	
2	Days without LTI	day	
<b>Lost Time Injury</b>			
3	Fatality (FT)	case	
4	Permanent Total/Partial Disability (PTPD)	case	
5	Lost Workday Case (LWDC)	case	
<b>Non-Lost Time Injury</b>			
6	Restricted Workday Case (RWDC)	case	
7	Medical Treatment Case (MTC)	case	
8	First Aid Case (FAC)	case	
<b>HSE indicators</b>			
9	Lost Time Injury Frequency (LTIF) <i>= (total LTI cases) x 1,000,000 / (total man-hours)</i>	case per 1,000,000 man- hrs worked	

10	Total Recordable Injury Frequency (TRIF) = $(Total\ Recordable\ Injuries) \times 1,000,000 / (total\ man-hrs)$	TRI per 1,000,000 man- hrs worked	
11	Days lost for LWDC	days	
12	Severity of LWDC = $(Total\ lost\ days\ for\ LWDC) / (total\ LWDC)$	days/case	
<b>Non-Injurious incident</b>			
13	Fire / Explosion incident	case	
14	Property Damage incident (PD)	case	
15	Hydrocarbon Release Incident	case	
16	Chemical spill incident	case	
17	Oil Spill to environment	case	
18	Occupational Illness (OI)	case	
19	Other Non-Injurious incident (See Definition below)	case	
<b>HSE performance efforts</b>			
20	Near-Miss Report	ea	
21	Safety observation reports	ea	
22	Emergency Drills/Exercises	ea	
23	Permit-To-Work	ea	
24	Audits and inspections	ea	
25	Safety meetings (including tool-box talks)	ea	
26	Job risk assessments (JSA, STING, TRA...)	ea	
<b>Environmental report</b>			
27	Hazardous waste	Kg	
28	Non-Hazardous waste	Kg	

A

29	Produced water discharge	m3	
<b>Others</b>			
30	Cost of incidents burdened by PVEP POC	USD	
31	Shutdown (incident)	case	
32	Downtime due to HSE incident	hrs	

SIGNATURE : \_\_\_\_\_ DATE : \_\_\_\_\_

NAME : \_\_\_\_\_ DESIGNATION : \_\_\_\_\_

## DEFINITION OF ACCIDENT TYPE

### 1. LOST TIME INJURY (LTI)

Any work related injury or illness which renders the injured person unable to perform his normal duties, on any day immediately following the day of the accident. It can be divided into four categories:

i) **Fatality**

Death due to work related injury or illness regardless of the time between injury or illness and death.

ii) **Permanent Total Disability**

A work related injury which incapacitates a person permanently and results in termination of employment.

iii) **Permanent Partial Disability**

A work related injury which results in the complete loss or permanent loss of use of any member or part of the body or any permanent impairment of functions of parts of the body, regardless of any pre-existing disability of the injured member or impaired body function.

iv) **Lost Workday Case**

A work related injury or illness other than a Permanent Partial Disability which renders the injured person temporarily unable to perform his normal duties, on any day immediately following the day of the accident.

### 2. NON LOST TIME INJURY (NLTI)

Any work related injury or illness other Lost Time Injury. It can further divide into three categories:

i) **Restricted Work Case**

A work related injury or illness which requires the person to be treated by doctor and is declared fit to return to do part of his normal work on restricted or light duties on the day immediately after following the accident/injury. (N/B. Restricted activity/light duties must be within the injured person's normal scope of work.)

ii) **Medical Treatment Case**

A work related injury or illness that involves neither lost workdays nor restricted workdays but which requires the injured to be treated by or under the specific orders of a physician or could be considered as being in the province of a physician.

iii) **First Aid Injury**

A work related injury or illness which requires minor treatment or subsequent observation of minor scratches, cuts, burns, splinters and so forth which do not ordinarily require medical care even though such treatment is provided by a physician or registered professional personnel, and the injured is able to resume his normal job function immediately after treatment.

### 3. FIRE/EXPLOSION

A

Any event involving fire/ explosion.

4. **PROPERTY LOSS/ DAMAGE**

Any accident which involves property damage/loss other than a fire or explosion.

5. **OIL SPILL**

Any accident involving spillage or release of oil and/or chemicals which cause pollution of air, water or ground.

6. **NEAR MISS**

Any event or condition which whilst not resulting in injury to person or loss or damage to equipment, plant or property, or pollution to the environment is recognised as having the potential to cause injury and/or property damage.

7. **STOP CARD (Safety Observation Card)**

Any Safe/Unsafe Act/Unsafe Condition that are reported on STOP Cards. Count each card as one effort

8. **OTHERS**

Any Incident/Accident is not above-mentioned

$$\text{LTIFREQUENCYRATE} = \frac{\text{No. of LTA} * 1,000,000}{\text{Man-hours Worked}}$$

$$\text{LTISEVERITYRATE} = \frac{\text{No. of Days Lost} * 1,000,000}{\text{Man-hours Worked}}$$

**APPENDIX VIII-4**  
**TYPICAL HSE HAZARD**

HEALTH	SAFETY	ENVIRONMENT
<p><b>Hazardous Materials</b></p> <ul style="list-style-type: none"> <li>• Sulphuric Acid</li> <li>• Caustic Soda</li> <li>• TENORM (Technologically Enhanced Naturally Occurring Radioactive Material)</li> <li>• Hydrogen Sulphide</li> <li>• Chlorine</li> <li>• Nitrogen</li> <li>• Solvent Fumes</li> <li>• Mercury</li> </ul> <p><b>Asphyxiation</b></p> <ul style="list-style-type: none"> <li>• Nitrogen</li> <li>• Oxygen Deficiency</li> </ul> <p><b>Radiological</b></p> <ul style="list-style-type: none"> <li>• Instrumentation</li> <li>• Inspection</li> <li>• TENORM (Technologically Enhanced Naturally Occurring Radioactive Material)</li> </ul> <p><b>Lightning</b></p> <ul style="list-style-type: none"> <li>• Lightning Strikes</li> </ul> <p><b>Burns</b></p> <ul style="list-style-type: none"> <li>• Hot &amp; Cold Material Equipment</li> </ul>	<p><b>Fire and Explosion</b></p> <ul style="list-style-type: none"> <li>• Flammability</li> <li>• Expansion</li> <li>• BLEVE (Boiling Liquid Expanding Vapour Explosion)</li> <li>• VCE (Vapour Cloud Explosion)</li> </ul> <p><b>Flammable Properties</b></p> <ul style="list-style-type: none"> <li>• Crude Oil</li> <li>• Hydrogen Gas</li> <li>• Hydrogen Sulphide</li> <li>• Hydrogen</li> <li>• Condensate</li> </ul> <p><b>Ignition Sources</b></p> <ul style="list-style-type: none"> <li>• Electrical</li> <li>• Stray Currents</li> <li>• Static</li> <li>• Lightning</li> <li>• Pyrophics</li> <li>• Smoking</li> <li>• Welding</li> <li>• Grinding/ Cutting</li> </ul> <p><b>Fire Types</b></p> <ul style="list-style-type: none"> <li>• Jet, Pool and Flash Fires</li> <li>• Lagging Fires</li> <li>• Smoke</li> </ul> <p><b>Water</b></p> <ul style="list-style-type: none"> <li>• Low Points</li> <li>• Draining</li> <li>• Hydrates</li> <li>• Emulsions/ Tank Layering</li> <li>• Dead Legs</li> </ul> <p><b>Air</b></p> <ul style="list-style-type: none"> <li>• Start-Up/ Shut-Down</li> <li>• Flare Systems</li> </ul>	<p><b>Airborne Emissions</b></p> <ul style="list-style-type: none"> <li>• Vents (CO<sub>2</sub>, CH<sub>4</sub>)</li> <li>• Flares</li> <li>• Fugitives</li> <li>• General Exhaust</li> </ul> <p><b>Underground Equipment Failure</b></p> <ul style="list-style-type: none"> <li>• Corrosion soil</li> <li>• Erosion contamination</li> </ul> <p><b>Jetty/ Ship Operation</b></p> <ul style="list-style-type: none"> <li>• Hoses/ Boom <ul style="list-style-type: none"> <li>• SBMs (Single Buoy Mooring)</li> </ul> </li> <li>• Ballast Disposal</li> <li>• Spillages</li> </ul> <p><b>Surface Water Run-offs</b></p> <ul style="list-style-type: none"> <li>• Contamination of waterways</li> </ul> <p><b>Process Effluents</b></p> <ul style="list-style-type: none"> <li>• Recovered Oils/ Ballast</li> <li>• Produced water – barium, zinc, trace of radioactive materials</li> <li>• Condensate water from Slug Catchers</li> <li>• Surge Vessel Liquids</li> <li>• From Drains</li> <li>• Triethylene Glycol</li> <li>• Biocides (glutaraldehyde)</li> <li>• Magnesium Hydroxide</li> </ul>

HEALTH	SAFETY	ENVIRONMENT
--------	--------	-------------

**Tank Farm Hazards**

- A. Floating Roofs (sinking drainage)
- B. Boil-Overs
- C. Internal Explosions

**Lifting**

- 1. Cranes
  - Heavy lifts
  - i) Chains
  - ii) Ropes
- D. Slings

**Machinery**

- 1 Guards
- 2 Protection

**Security**

**Electricity**

- E. Electrocutation
- F. Overhead Lines
- G. HV systems/ arcing

**Excavations**

- H. Buried Facilities
- I. Collapses
- J. Gas Accumulation

**Working at Height**

- K. Scaffolding
- L. Ladders
- M. Fragile Roofs

**Drilling Operations**

- N. Blowout – Fire/ Explosion
- O. Shallow Gas Pockets/ Over Pressure
- P. Gas in Mud>Returns
- Q. Hydrogen Sulphide

HEALTH	SAFETY	ENVIRONMENT
--------	--------	-------------

**Floating Drill Vessels**

- A. Capsize (stability)
- B. Fire/ Explosion
- C. Collision
- 1. Drownings
- 2. FPSV

**Passing Vessels (Collision)**

- D. Fishing
- E. Submarine

**Aircraft Crash**

- F. Helicopter Crash
  - Sea ditching
  - Landing/ take-off

**Falling Objects**

- G. Cranes (supplies)
- H. Drilling Derrick (pipe)
- I. Maintenance

A



**DANH SÁCH NHÀ THẦU CHO GÓI THẦU SỐ:  
PVEP POC-26-10053**

**Retrofit of Diagonal Brace-to-Column Connection Joints of Dai Hung 01 FPU**

1. ĐĂNG KIỂM DNV VIỆT NAM (DET NORSKE VERITAS)
  - Nguyễn Duy Thụy – Giám đốc
  - Email: [thuy.nguyen@dnv.com](mailto:thuy.nguyen@dnv.com)
2. VIETSOVPETRO
  - 105 Lê Lợi, P.Thắng Nhì, TP.Vũng Tàu, Tỉnh Bà Rịa-Vũng Tàu, Việt Nam
  - Điện thoại: +84.254.3839 871 - Fax: +84.254.3839857
  - Email: [vspadmin@vietsov.com.vn](mailto:vspadmin@vietsov.com.vn)
3. ĐĂNG KIỂM ABS (AMERICAN BUREAU OF SHIPPING)
  - Main Office ABS Group
  - 438 Alexandra Road, #09-01 Alexandra Point Singapore 119958 Republic of Singapore
  - Tel: +65 6270 8663
  - Email: [info@abs-group.com](mailto:info@abs-group.com)
  - Suite 290, Petro Vietnam Tower, No.8 Hoang Dieu St., Ward 1, Vung Tau City
  - Phone: +84-254-3527-233 +84-254-3512-928 Fax: +84-254-3527-322
  - Email: [ABSVungTau@eagle.org](mailto:ABSVungTau@eagle.org)
4. VIỆN XÂY DỰNG CÔNG TRÌNH BIỂN
  - P504, nhà Thí nghiệm, trường Đại học Xây dựng, 55 Giải Phóng, HN.
  - 024.6673.9173 - 024.3869.9698
  - [info@icoffshore.com.vn](mailto:info@icoffshore.com.vn)
  - <http://icoffshore.com.vn>
5. CÔNG TY CỔ PHẦN ĐẦU TƯ KỸ THUẬT VÀ PHÁT TRIỂN CÔNG NGHỆ BIỂN VIỆT NAM - Vimartec
  - Nguyễn Ngọc Vinh – Giám đốc
  - Email: [nnvinh@vimartec.com.vn](mailto:nnvinh@vimartec.com.vn)

